

PART NO. WJBM-EN-00

HITACHI

Reliable solutions

Workshop Manual

ZX

870-5A

870LC-5A

890H-5A

890LCH-5A

ZX870-5A • 870LC-5A • 890H-5A • 890LCH-5A HYDRAULIC EXCAVATOR WORKSHOP MANUAL

 **Hitachi Construction Machinery Co., Ltd.**

URL:<http://www.hitachi-c-m.com>

Hydraulic Excavator

Service Manual consists of the following separate Part No.

Technical Manual (Operational Principle)	: Vol. No.TOJBM-EN
Technical Manual (Troubleshooting)	: Vol. No.TTJBM-EN
Workshop Manual	: Vol. No.WJBM-EN
Engine Manual	: Vol. No.ETJBM-EN, EWJBM-EN

PRINTED IN JAPAN (K) 2016, 06

WJBM-EN-00

SECTION AND GROUP CONTENTS

WORKSHOP MANUAL

SECTION 1 GENERAL INFORMATION

Group 1 Precautions for Disassembling and Assembling
Group 2 Tightening
Group 3 Painting
Group 4 Bleeding Air
Group 5 Pressure Release Procedure
Group 6 Preparation

SECTION 2 MAINTENANCE STANDARD

Group 1 Upperstructure
Group 2 Undercarriage
Group 3 Front Attachment

SECTION 3 UPPERSTRUCTURE

Group 1 Cab
Group 2 Counterweight
Group 3 Main Frame
Group 4 Engine
Group 8 Pump Device
Group 9 Control Valve
Group 10 Swing Device
Group 11 Pilot Valve
Group 12 Solenoid Valve
Group 13 Signal Control Valve
Group 14 Shockless Valve
Group 15 Fan Valve
Group 16 Fan Motor

SECTION 4 UNDERCARRIAGE

Group 1 Swing Bearing
Group 2 Travel Device
Group 3 Center Joint
Group 4 Track Adjuster
Group 5 Front Idler
Group 6 Upper and Lower Roller
Group 7 Track

SECTION 5 ATTACHMENT

Group 1 Front Attachment
Group 2 Cylinder

All information, illustrations and specifications in this manual are based on the latest product information available at the time of publication. The right is reserved to make changes at any time without notice.

TECHNICAL MANUAL (Operational Principle)	TECHNICAL MANUAL (Troubleshooting)
<p>SECTION 1 GENERAL</p> <ul style="list-style-type: none"> Group 1 Specification Group 2 Component Layout Group 3 Component Specifications <p>SECTION 2 SYSTEM</p> <ul style="list-style-type: none"> Group 1 Controller Group 2 Control System Group 3 ECM System Group 4 Hydraulic System Group 5 Electrical System <p>SECTION 3 COMPONENT OPERATION</p> <ul style="list-style-type: none"> Group 1 Pump Device Group 2 Swing Device Group 3 Control Valve Group 4 Pilot Valve Group 5 Travel Device Group 6 Signal Control Valve Group 7 Others (Upperstructure) Group 8 Others (Undercarriage) 	<p>SECTION 4 OPERATIONAL PERFORMANCE TEST</p> <ul style="list-style-type: none"> Group 1 Introduction Group 2 Standard Group 3 Engine Test Group 4 Excavator Test Group 5 Component Test Group 6 Adjustment <p>SECTION 5 TROUBLESHOOTING</p> <ul style="list-style-type: none"> Group 1 Diagnosing Procedure Group 2 Monitor Group 3 e-Service Group 4 Component Layout Group 5 Troubleshooting A Group 6 Troubleshooting B Group 7 Air Conditioner

SECTION 1

GENERAL

CONTENTS

Group 1 Precautions for Disassembling and Assembling

Precautions for Disassembling and Assembling	W1-1-1-1
--	----------

Group 2 Tightening

Tightening Bolts and Nuts	W1-2-1-1
Piping Joint	W1-2-1-4

Group 3 Painting

Painting specification	W1-3-1-1
Final painted color	W1-3-1-1

Group 4 Bleeding Air

Bleeding Air from Hydraulic Oil Tank (Pressure Release)	W1-4-1-1
Bleeding Air from Hydraulic System	W1-4-1-2
Bleeding Air from Fuel System	W1-4-1-3
Bleeding Air from Expansion Tank (Radiator) (Pressure Release)	W1-4-1-5

Group 5 Pressure Release Procedure

Hydraulic Circuit Pressure Release Procedure	W1-5-1-1
--	----------

Group 6 Preparation

Preparation before Inspection and Maintenance	W1-6-1-1
---	----------

(Blank)

SECTION 1 GENERAL

Group 1 Precautions for Disassembling and Assembling

Precautions for Disassembling and Assembling

Precautions for Disassembling

- **Clean the Machine**
Thoroughly wash the machine before bringing it into the shop. Bringing a dirty machine into the shop may cause machine components to be contaminated during disassembling / assembling, resulting in damage to machine components as well as decreased efficiency in service work.
- **Inspect the Machine**
Be sure to thoroughly understand all disassembling / assembling procedures beforehand to help avoid incorrect disassembling of components as well as personal injury.
Check and record the items listed below to prevent problems from occurring in the future.
 - The machine model, machine serial number, and hour meter reading.
 - Reason for disassembly (symptoms, failed parts, and causes).
 - Clogging of filters and oil, water, or air leaks, if any. Capacities and condition of lubricants.
 - Loose or damaged parts.
- **Prepare and Clean Tools and Disassembly Area**
Prepare the necessary tools to be used and the area for disassembling work.

Precautions for Disassembling and Assembling

- **Precautions for Disassembling**
 - Cap the open ends in case the hoses and pipes have been disconnected. In addition, attach identification tags onto the connectors, hoses, and pipes for assembling.
 - Before disassembling, clean the exterior of the components and place on a workbench.
 - Drain hydraulic oil and gear oil from the hydraulic components and reduction gear.
 - Be sure to provide appropriate containers for draining fluids.
 - Use matching marks for easier reassembling if necessary.
 - Be sure to use the specified special tools when instructed.

- If a part or component cannot be removed after removing its securing nuts and bolts, do not attempt to remove it forcibly. Find the cause (s), and then take the appropriate measures to remove it.
 - Orderly arrange disassembled parts. Mark and tag them if necessary.
 - Store common parts, such as bolts and nuts with reference to where they are to be used and in a manner that will prevent loss.
 - Inspect the contact or sliding surfaces of disassembled parts for abnormal wear, sticking, or other damage.
 - Measure and record the degree of wear and clearances.
- **Precautions for Assembling**
 - Be sure to clean all parts and inspect them for any damage. If any damage is found, repair or replace part.
 - Dirt or debris on the contact or sliding surfaces may shorten the service life of the machine. Take care not to contaminate any contact or sliding surfaces.
 - Apply appropriate lubricant oil to parts in order to prevent them from seizing.
 - Be sure to replace O-rings, backup rings, oil seals, and floating seals with new ones once they have been disassembled. Apply grease before installing.
 - Be sure that liquid-gasket-applied surfaces are clean and dry.
 - If an anti-corrosive agent has been used on a new part, be sure to thoroughly clean the part to remove the agent.
 - Fit the matching marks made when disassembling and assemble them.
 - Be sure to use the designated tools to assemble bearings, bushings, and oil seals.
 - Keep a record of the number of tools used for disassembly / assembly. After assembling is completed, count the number of tools so as to make sure that no forgotten tools remain in the assembled machine.

SECTION 1 GENERAL

Group 1 Precautions for Disassembling and Assembling

Precautions for Using Floating Seal

1. In general, replace the floating seal with a new one after disassembling.

If the floating seal is required to be reused, follow these procedures:

- Keep seal rings together as a matched set with seal ring (1) surfaces together. Apply oil to sliding surface (e) of seal ring (1).
- Check sliding surface (e) of seal ring (1) for scuffing, scoring, corrosion, deformation, or uneven wear. Check the step part of seal ring (1).
- Check O-ring (2) for tears, breaks, deformation, or hardening.

2. If incorrectly assembled, oil leakage or damage will occur. Be sure to do the following to prevent trouble.

- Clean the floating seal and seal mounting bores with cleaning solvent.

Use a wire brush to remove mud, rust, or dirt from seal mounting bores. After cleaning, thoroughly dry parts with compressed air.

- Clean seal ring (1) and O-ring (2) mounting bores. Check the bore surface for scuffing or scoring by touching the surface with finger.
- After installing the floating seal, check that O-ring (2) is not twisted, and that it is installed correctly on seal ring (1).
- After installing the floating seal, check that O-ring (2) and seal ring sliding surface (e) is parallel with seal mating surface (f) by measuring the distances between (e) and (f) at point (A) and (B), as illustrated. If these distances differ, correct O-ring (2) seating.

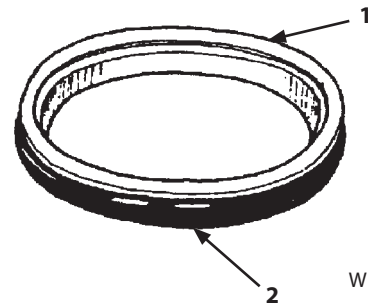

W178-02-11-001

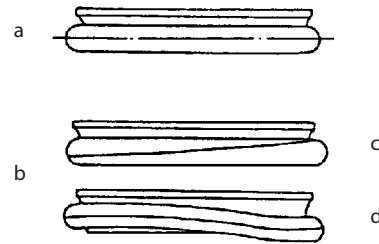
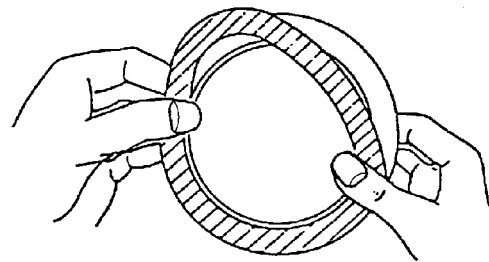

W178-02-11-002

- a - Correct
- b - Incorrect
- c - Twist of O-Ring
- d - Bend of O-Ring

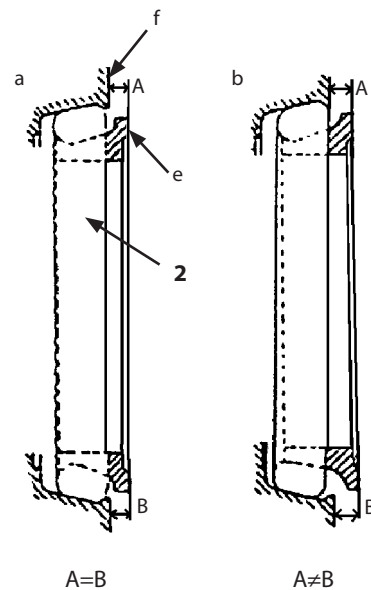

W178-02-11-003

- a - Correct
- b - Incorrect
- e - Sliding Surface
- f - Seal Mating Surface

SECTION 1 GENERAL

Group 1 Precautions for Disassembling and Assembling

Precautions for Using Nylon Sling

1. Follow the precautions below to use nylon slings safely.
 - Attach protectors (soft material) on the corners of the load so that the nylon sling does not directly contact the corners. This will prevent the nylon sling from being damaged and the lifted load from slipping.
 - Lower the temperature of the lifted load to lower than 100 °C (212 °F). If the temperature of the lifted load is over 100 °C (212 °F), do not lift the load.
 - Do not lift acid or alkali chemicals.
 - Take care not to allow the sling to become wet. The load may slip.
 - When required to use more than one sling, use slings with the same width and length to keep the lifted load balanced.
 - When lifting a load using an eyehole, be sure to eliminate any gaps between the sling and load. (Refer to the right illustration.) Reduce the load weight so that it is less than 80 % of the sling breaking force.
 - Avoid using twisted, bound, connected, or hitched slings.
 - Do not place any object on twisted or bent slings. (Refer to the right illustration.)
 - When removing the slings from under the load, take care not to damage the nylon slings. Avoid contact with protrusions.
 - Avoid dragging slings on the ground, throwing slings, or pushing slings with a metal object.
 - When using with other types of slings (wire rope) or accessories (shackle), protect the joint so that the nylon sling is not damaged.
 - Store the nylon slings indoors so that they won't deteriorate with heat, sun light, or chemicals.

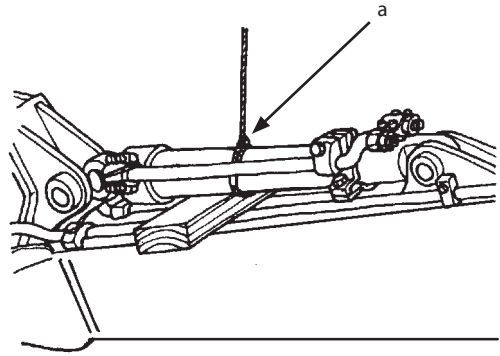

W102-04-02-016

a - Correct Eyehole Lifting Method

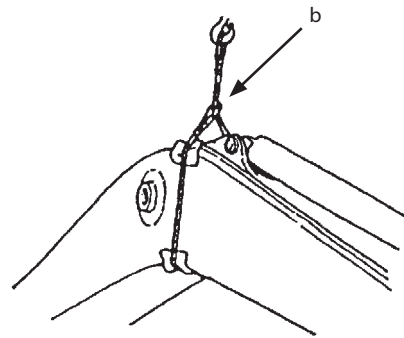

W105-04-01-008

b - Incorrect Eyehole Lifting Method

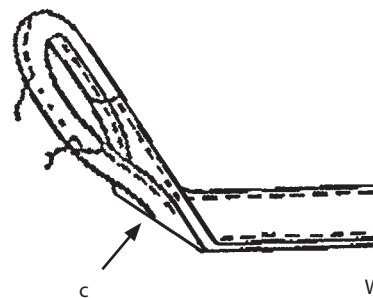

W162-01-01-009

c - Bent of Sling

SECTION 1 GENERAL

Group 1 Precautions for Disassembling and Assembling

CAUTION: If a load is lifted with a damaged nylon sling, serious personal injury may result. Be sure to visually check the nylon sling for any damage before using.

2. Before using a nylon sling, visually check the nylon sling for any damage corresponding to following examples. If any damage is found, cut and discard the sling.
Even if no damage is found, do not use slings older than 7 years.

Damaged Appearance

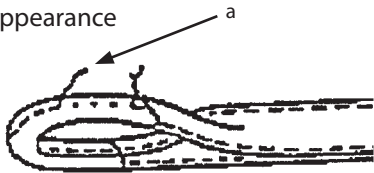

W162-01-01-002

a - Broken Sewing Thread

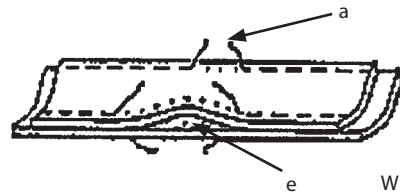

W162-01-01-006

a - Broken Sewing Thread e - Separation of Belt



W162-01-01-003

b - Scuffing

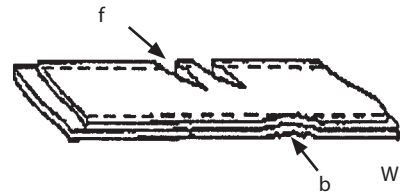

W162-01-01-007

b - Scuffing f - Scoring

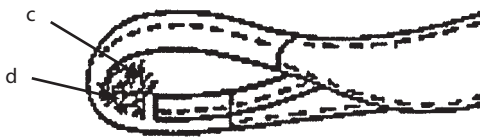

W162-01-01-004

c - Fuzz d - Broken Sewing Thread

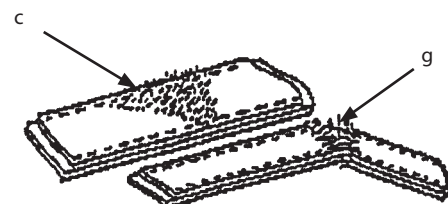

W162-01-01-008

c - Fuzz g - Broken Warp



W162-01-01-005

a - Broken Sewing Thread

SECTION 1 GENERAL

Group 1 Precautions for Disassembling and Assembling

Maintenance Standard Terminology

"Standard"

1. Dimension for parts on a new machine.
2. Dimension of new components or assemblies adjusted to specification. Allowable errors will be indicated if necessary.

"Allowable Limit"

1. Normal machine performance cannot be accomplished after exceeding this limit.
2. Repair or adjustment is difficult after exceeding this limit.
3. Repair or adjustment is impossible after exceeding this limit.
Therefore, in consideration of operation efficiency and maintenance expense, proper maintenance shall be carried out before reaching the "Allowable Limit".

SECTION 1 GENERAL
Group 1 Precautions for Disassembling and Assembling

(Blank)

SECTION 1 GENERAL

Group 2 Tightening

Tightening Bolts and Nuts

CAUTION: Use tools appropriate for the work to be done. Makeshift tools and procedures can create safety hazards. For loosening and tightening nuts and bolts, use correct size tools. Otherwise, tightening tools may slip, potentially causing personal injury.



WDAA-01-02-001



Bolt Types

Tighten the nuts or bolts correctly to the torque specifications.

As the different types and grades of bolt are used, use and tighten the correct bolts correctly when assembling the machine or components.

Specified Tightening Torque Chart

2013/09

Bolt Dia. mm	Hexagon Head Bolt						Socket Bolt			
	 WDAA-01-02-002		 WDAA-01-02-003		 WDAA-01-02-004		Wrench Size mm	Socket Bolt		Wrench Size mm
	N·m	(lbf·ft)	N·m	(lbf·ft)	N·m	(lbf·ft)		N·m	(lbf·ft)	
6					3 to 4	(2.2 to 3)	10			5
8	30	(22)	20	(15)	10	(7.4)	13	20	(15)	6
10	65	(48)	50	(37)	20	(15)	17	50	(37)	8
12	110	(81)	90	(66)	35	(26)	19	90	(66)	10
14	180	(133)	140	(103)	55	(41)	22	140	(103)	12
16	270	(200)	210	(155)	80	(59)	24	210	(155)	14
18	400	(300)	300	(220)	120	(89)	27	300	(220)	14
20	550	(410)	400	(300)	170	(125)	30	400	(300)	17
22	750	(550)	550	(410)	220	(162)	32			
24	950	(700)	700	(520)	280	(205)	36			
27	1400	(1030)	1050	(770)	400	(300)	41			
30	1950	(1440)	1450	(1070)	550	(410)	46			
33	2600	(1920)	1950	(1440)	750	(550)	50			
36	3200	(2360)	2450	(1810)	950	(700)	55			

SECTION 1 GENERAL

Group 2 Tightening

IMPORTANT: The following items are applied to both fine and coarse pitch threads.

- Apply lubricant to the bolts and nuts in order to reduce friction coefficient of them. (For example, spindle oil with white zinc B dissolved in it)
- Torque tolerance is $\pm 10\%$.
- Use the bolts of correct length. The bolts that are too long cannot be tightened as the bolt tip comes into contact with the bottom of bolt hole. Also the bolts that are too short cannot develop sufficient tightening force.
- The torque given in the chart on the previous page are for general use only, however, a different torque is given for a specific application. Use the specified torque.
- Clean the nut and bolt threads and remove dirt or corrosion before installing.

Tightening Order

When tightening two or more bolts, tighten them alternately, as shown, to ensure even tightening.

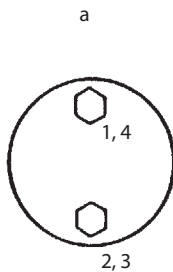

a - Equally tighten upper and lower alternately

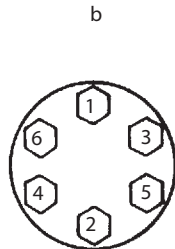

b - Tighten diagonally

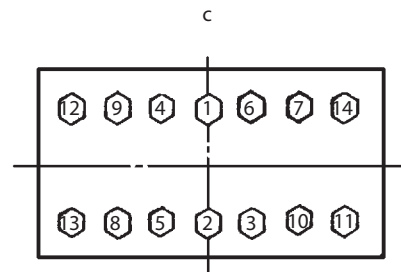

c - Tighten from center diagonally

W105-01-01-003

SECTION 1 GENERAL

Group 2 Tightening

Precautions for Spilt Flange

IMPORTANT:

- Clean the sealing surfaces. Check if there are any scratches and roughness on the surface of the seal that cause oil leaks and damage to the O-ring.
- Use only specified O-rings. Inspect O-rings for any damage. Do not file the O-ring surfaces. When installing O-ring into a groove, use grease in order to hold O-ring in place.
- While tightening the bolt by hand, check that flange is installed to the port correctly. Do not pinch the O-ring.
- Tighten the bolts up and down, right and left alternately, in order to ensure even tightening to the specified torque.
- Do not use an impact wrench. It is difficult to evenly tighten the bolts by using an impact wrench. Using an impact wrench often causes uneven tightening of bolts or damage to O-rings.

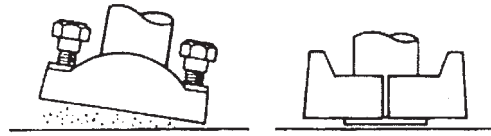

WDAA-01-02-005

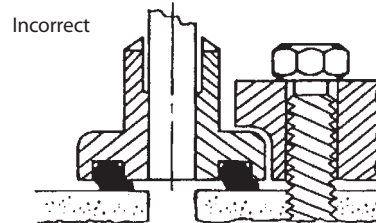

WDAA-01-02-006



W105-01-01-008

Nut and Bolt Locking

- Lock Plate

IMPORTANT: Do not reuse the lock plates. Do not try to bend the same point twice.

- Split Pin

IMPORTANT: Do not turn in the loosening direction in order to align the grooves and holes on the nut. Always turn in the tightening direction. Do not reuse the split pins.

- Wire

IMPORTANT: Attach wires to bolts in the bolt-tightening direction. Do not reuse the wires.

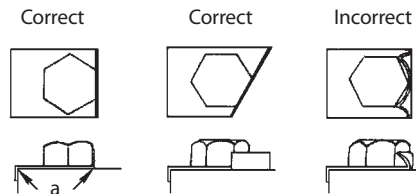
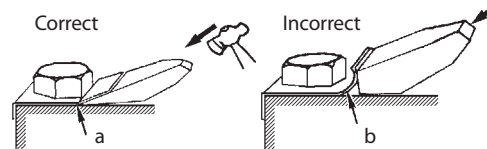

WDAA-01-02-007

a- Bend along edge sharply b- Do not bend it round

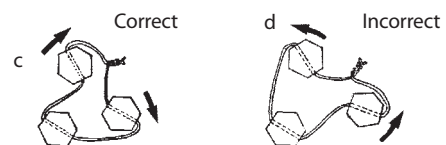
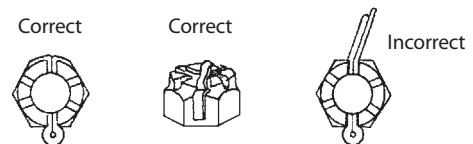

WDAA-01-02-008

c- Tighten d- Loosen

SECTION 1 GENERAL

Group 2 Tightening

Piping Joint

IMPORTANT:

- The torque given in table below are for general use only, however, a different torque is given for a specific application. Use the specified torque.
- Apply lubricant, such as the Grease Spray to the bolts and nuts in order to reduce friction coefficient of them.
- Torque tolerance is $\pm 10\%$.
- Slightly apply lubricant onto the threads first by using the Grease Spray.

Thanks for your reading.

Please click here to download complete manual instantly.

And can also choose other manuals.

Feel free --->write to me with any questions.

Our service email:

manuals007@hotmail.com