

PART NO. WACC90-EN-00

HITACHI

Reliable solutions

Workshop Manual

ZX26U-5A Hydraulic Excavator

ZX26U-5A HYDRAULIC EXCAVATOR WORKSHOP MANUAL

 **Hitachi Construction Machinery Co., Ltd.**

URL:<http://www.hitachi-c-m.com>

PRINTED IN JAPAN (K) 2015, 06

WACC90-EN-00

Service Manual consists of the following separate Part No.

Technical Manual	: Vol. No.TACC90-EN
Workshop Manual	: Vol. No.WACC90-EN
Engine Manual	: Vol. No.EABA-EN

INTRODUCTION

To The Reader

This manual is written for an experienced technician to provide technical information needed to maintain and repair this machine.

The machine specification and description according to destination may be explained on this manual.

- Be sure to thoroughly read this manual for correct product information and service procedures.

- If you have any questions or comments, at if you found any errors regarding the contents of this manual, please contact using "Service Manual Revision Request Form" at the end of this manual. (Note: Do not tear off the form. Copy it for usage.):

- Publications Marketing & Product Support Hitachi Construction Machinery Co. Ltd.
- TEL: 81-29-832-7084
- FAX: 81-29-831-1162
- E-mail: dc@hitachi-kenki.com

Additional References

Please refer to the other materials (operator's manual, parts catalog, engine technical material and Hitachi training material etc.) in addition to this manual.

Manual Composition

This manual consists the Technical Manual, the Workshop Manual and the Engine Manual.

- Information included in the Technical Manual: Technical information needed for redelivery and delivery, operation and activation of all devices and systems, operational performance tests, and troubleshooting procedures.

- Information included in the Workshop Manual: Technical information needed for maintenance and repair of the machine, tools and devices needed for maintenance and repair, maintenance standards, and removal / installation and assemble / disassemble procedures.

- Information included in the Engine Manual: Technical information needed for redelivery and delivery and maintenance and repair of the machine, operation and activation of all devices and systems, troubleshooting and assemble / disassemble procedures.

Page Number

Each page has a number, located on the center lower part of the page, and each number contains the following information:

Example:

- Technical Manual: T 1-3-5

T	Technical Manual
1	Section Number
3	Group Number
5	Consecutive Page Number for Each Group

- Workshop Manual: W 1-3-2-5

W	Workshop Manual
1	Section Number
3	Group Number
2	Sub Group Number
5	Consecutive Page Number for Each Group

INTRODUCTION

Safety Alert Symbol and Headline Notations

In this manual, the following safety alert symbol and signal words are used to alert the reader to the potential for personal injury of machine damage.

 This is the safety alert symbol. When you see this symbol, be alert to the potential for personal injury. Never fail to follow the safety instructions prescribed along with the safety alert symbol. The safety alert symbol is also used to draw attention to component/part weights. To avoid injury and damage, be sure to use appropriate lifting techniques and equipment when lifting heavy parts.

CAUTION:

Indicates potentially hazardous situation which could, if not avoided, result in personal injury or death.

IMPORTANT:

Indicates a situation which, if not conformed to the instructions, could result in damage to the machine.

NOTE:

Indicates supplementary technical information or know-how.

Units Used

SI Units (International System of Units) are used in this manual. MKSA system units and English units are also indicated in parentheses just behind SI units.

Example: 24.5 MPa (250 kgf/cm², 3560 psi)

A table for conversion from SI units to other system units is shown below for reference purposes.

Quantity	To Convert From	Into	Multiply By
Length	mm	in	0.03937
	mm	ft	0.003281
Volume	L	US gal	0.2642
	L	US qt	1.057
	m ³	yd ³	1.308
Weight	kg	lb	2.205
Force	N	kgf	0.10197
	N	lbf	0.2248
Torque	N·m	kgf·m	0.10197
Pressure	MPa	kgf/cm ²	10.197
	MPa	psi	145.0
Power	kW	PS	1.360
	kW	HP	1.341
Temperature	°C	°F	°C×1.8+32
Velocity	km/h	mph	0.6214
	min ⁻¹	rpm	1.0
Flow rate	L/min	US gpm	0.2642
	mL/rev	cc/rev	1.0

 NOTE: The numerical value in this manual might be different from the above-mentioned table.

SYMBOL AND ABBREVIATION

Symbol / Abbreviation	Name	Explanation
TO	Technical manual (Operational principle)	Technical manual (Operational Principle).
TT	Technical manual (Troubleshooting)	Technical manual (Troubleshooting).
T/M	Technical manual	Technical manual.
W, W/M	Workshop manual	Workshop manual (Removal and Installation, Disassembly and Assembly).
E-ECU	Engine Controller	Engine controller. E-ECU controls fuel injection amount according to the machine operating condition.
GSM	Global System for Mobile communications controller	Communication controller. GSM is a type of wireless communication system, is used in more than on 100 countries around Europe and Asia, and becomes the factual global standards of the mobile telephone.
GPS	Global Positioning System	Global positioning system.
CAN	Controller Area Network	CAN communication. CAN is a serial communications protocol internationally-standardized by ISO (International Organization for Standardization).
A/C	Air Conditioner	Air conditioner.
OP, OPT	Option	Optional component.
MPDr.	Maintenance Pro Dr.	MPDr. is software that troubleshooting, monitoring, and adjustment.
A/I	Auto-Idle	Auto-idle.
WU	Warming-Up	Warming-up.
Li	Low (Slow) Idle	Slow idle engine speed.
ATT	Attachment	Attachment. Attachment is optional parts such as breaker, crusher, and pulverizer in this manual.
HI, Hi	High	Travel fast position.
LO, Lo	Low	Travel slow position.
EGR	Exhaust Gas Recirculation	The EGR control re-circulates a part of exhaust gas in the intake manifold and combines it with intake-air. Therefore, combustion temperature is lowered and generation of oxide of nitrogen (NOx) is controlled.
CSD	Cold Start Device	Engine start device at low temperature. It increasingly advances the fuel injection timing and increases the fuel injection amount a little when coolant temperature is less than 5 °C. Therefore, the engine starting is improved.

SYMBOL AND ABBREVIATION

(Blank)

SAFETY

Recognize Safety Information

- These are the **SAFETY ALERT SYMBOLS**.
 - When you see these symbols on your machine or in this manual, be alert to the potential for personal injury.
 - Follow recommended precautions and safe operating practices.



SA-688

Understand Signal Words

- On machine safety signs, signal words designating the degree or level of hazard - **DANGER**, **WARNING**, or **CAUTION** - are used with the safety alert symbol.
 - **DANGER** indicates an imminently hazardous situation which, if not avoided, will result in death or serious injury.
 - **WARNING** indicates a potentially hazardous situation which, if not avoided, could result in death or serious injury.
 - **CAUTION** indicates a potentially hazardous situation which, if not avoided, may result in minor or moderate injury.
 - **DANGER or WARNING safety signs** are located near specific hazards. General precautions are listed on **CAUTION safety signs**.
 - Some safety signs do not use any of the designated signal words above after the safety alert symbol are occasionally used on this machine.
- **CAUTION** also calls attention to safety message in this manual.
- To avoid confusing machine protection with personal safety messages, a signal word **IMPORTANT** indicates a situation which, if not avoided, could result in damage to the machine.



IMPORTANT



SA-1223

 **NOTE:** indicates an additional explanation for an element of information.

SAFETY

Follow Safety Instructions

- Carefully read and follow all safety signs on the machine as well as all safety messages in operator's manual.
- Safety signs must be installed, maintained and replaced if damaged.
 - If a safety sign or operator's manual is damaged or missing, order a replacement from your authorized dealer in the same way you order other replacement parts (be sure to state machine model and serial number when ordering).
- Allow only properly trained, qualified, authorized personnel to operate the machine.
- Learn how to correctly operate and service the machine.
- Keep your machine in proper working condition.
 - Unauthorized modifications of the machine may impair its function and/or safety and affect machine life.
 - Do not modify any machine parts without authorization. Failure to do so may deteriorate the part safety, function, and/or service life. In addition, personal accident, machine trouble, and/or damage to material caused by unauthorized modifications will void Hitachi Warranty Policy.
 - Do not use attachments and/or optional parts or equipment not authorized by Hitachi. Failure to do so may deteriorate the safety, function, and/or service life of the machine. In addition, personal accident, machine trouble, and/or damage to material caused by using unauthorized attachments and/or optional parts or equipment will void Hitachi Warranty Policy.
- The safety messages in this SAFETY chapter are intended to illustrate basic safety procedures of machines. However it is impossible for these safety messages to cover every possible hazardous situation you may encounter. If you have any questions concerning safety, you should first consult your supervisor and/or your authorized dealer before operating or performing maintenance work on the machine.



SA-003

SAFETY

Prepare For Emergencies

- Be prepared if a fire starts or if an accident occurs.
 - Keep a first aid kit and fire extinguisher on hand.
 - Thoroughly read and understand the label attached on the fire extinguisher and use it properly.
 - To ensure that a fire extinguisher can be always used when necessary, check and service the fire extinguisher at the recommended intervals as specified in the fire-extinguisher manual.
 - Establish emergency procedure guidelines to cope with any fire or accidents which may occur.
 - Keep emergency numbers for doctors, ambulance service, hospitals, and fire department posted near your telephone.



SA-437

Wear Protective Clothing

- Wear close fitting clothing and safety equipment appropriate to the job.

You may need:

- A hard hat
- Safety belt
- Safety shoes
- Safety glasses, goggles, or face shield
- Heavy gloves
- Hearing protection
- Reflective clothing
- Wet weather gear
- Respirator or filter mask

Be sure to wear the correct equipment and clothing for the job. Do not take any chances.

- Avoid wearing loose clothing, jewelry, or other items that can catch on control levers or other parts of the machine.
- Operating equipment safely requires the full attention of the operator. Do not wear radio or music headphones while operating the machine.

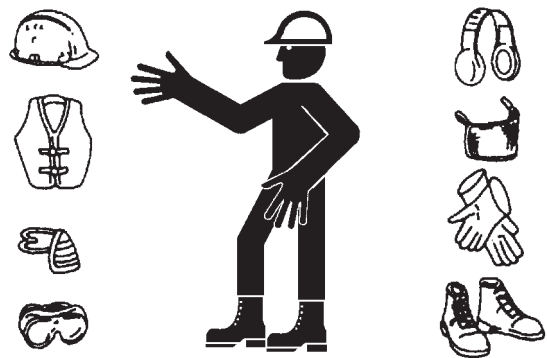

SA-438

SAFETY

Protect Against Noise

- Prolonged exposure to loud noise can cause impairment or loss of hearing.
 - Wear a suitable hearing protective device such as earmuffs or earplugs to protect against objectionable or uncomfortably loud noises.



SA-434

Inspect Machine

- If any abnormality is found, be sure to repair it immediately before operating the machine.
 - In the walk-around inspection, be sure to cover all points described in the “Daily Inspection” section in the operator’s manual.



SA-435

SAFETY

General Precautions for Cab

- Always keep inside the cab clean by observing instructions below, to prevent any personal accidents from occurring.
 - Before entering the cab, thoroughly remove all dirt and/or oil such as mud, grease, soil or stones that may mess up the cab from the soles of your work boots. If any controls such as a pedal is operated while with dirt and/or oil on the soles of the operator's work boots, the operator's foot may slip off the pedal, possibly resulting in a personal accident.
 - Do not mess up around the operator's seat with parts, tools, soil, stones, obstacles that may fold up or turn over, cans or lunch box. The levers or pedals become inoperable if obstacle jams in operation stroke of the travel levers/pedals, pilot control shut-off lever or control levers, which may result in serious injury or death.
 - Avoid storing transparent bottles in the cab. Do not attach any transparent type window decorations on the windowpanes as they may focus sunlight, possibly starting a fire.
 - Refrain from listening to the radio, or using music headphones or mobile telephones in the cab while operating the machine.
 - Keep all flammable objects and/or explosives away from the machine.
 - After using the ashtray, always cover it to extinguish the match and/or tobacco.
 - Do not leave cigarette lighters in the cab. If the temperature in the cab increases, the lighter may explode.
 - Use proper floor mat dedicated to the machine. If another floor mat is used, it may be displaced and contact with the travel pedals during operation, resulting in serious injury or death.

Use Handrails and Steps

- Falling is one of the major causes of personal injury.
 - When you get on and off the machine, always use the crawler instead of the step for safety. Also get on and off from the position of the crawler that can secure your feet space enough.
 - When you get on and off the machine, always face the machine.
 - Maintain a three-point contact with the steps and handrails.
 - Do not use any controls as handholds.
 - Never jump on or off the machine. Never mount or dismount a moving machine.
 - In case adhered slippery material such as oil, grease, or mud is present on steps, handrails, or platforms, thoroughly remove such material.



SA-439

SAFETY

Adjust the Operator's Seat

- A poorly adjusted seat for either the operator or the work at hand may quickly fatigue the operator leading to mis-operation of the machine.
 - The seat should be adjusted whenever the operator for the machine changes.
 - The operator should be able to fully depress the pedals and to correctly operate the control levers with his back firmly against the seat back.
 - If not, readjust the seat forward or backward, and check again.



SA-378

Ensure Safety Before Rising From or Leaving Operator's Seat

- Before rising from the operator's seat to open/close cab front window or to adjust the seat position, be sure to first lower the front attachment to the ground and then move the pilot control shut-off lever to the LOCK position. Failure to do so may allow the machine to unexpectedly move when a body part unintentionally comes in contact with a control lever, possibly resulting in serious personal injury or death.
- Before leaving the machine, be sure to first lower the front attachment to the ground and then move the pilot control shut-off lever to the LOCK position. Turn the key switch OFF to stop the engine.
- Before leaving the machine, close all windows, doors, and access covers and lock them up.

SAFETY

Fasten Your Seat Belt

- If the machine should overturn, the operator may become injured and/or thrown from the cab. Additionally the operator may be crushed by the overturning machine, resulting in serious injury or death.
 - Be sure to remain seated with the seat belt securely fastened whenever operating the machine.
 - Prior to operating the machine, thoroughly examine webbing, buckle and attaching hardware. If any item is damaged or worn, replace the seat belt or component before operating the machine. Replace the seat belt at least once every 3 years regardless of appearance.



SA-237

Move and Operate Machine Safely

- Always be aware that there is a potential danger around the machine while operating the machine.
 - Take extra care not to run over bystanders. Confirm the location of bystanders before moving, swinging, or operating the machine.
 - Always keep the travel alarm and horn in working condition (if equipped).
 - Before starting to move or operate the machine, sound the travel alarm and horn to alert bystanders.
 - Use a signal person when moving, swinging, or operating the machine in congested areas. Locate the signal person so that the operator can always witness the signal person.
 - Coordinate the meanings of all safety signs, hand signals and marks before starting the machine. Appoint a person who is responsible to make a signal and/or guidance.
 - Never allow any persons or obstacles to enter the machine operation areas.
 - Use appropriate illumination.



SA-1291

SAFETY

Operate Only From Operator's Seat

- Inappropriate engine starting procedures may cause the machine to runaway, possibly resulting in serious injury or death.
 - Start the engine only when seated in the operator's seat.
 - NEVER start the engine while standing on the tracks or on ground.
 - Do not start engine by shorting across starter terminals. A hazardous situation may be created and/or possible damage to the machine may result.
 - Before starting the engine, confirm that all control levers are in neutral.



SA-444

Jump Starting

- Failure to follow correct jump starting procedures could result in a battery explosion or a runaway machine.
 - If the engine must be jump started, be sure to follow the instructions shown in the "OPERATING ENGINE" chapter.
 - The operator must be seated in the operator's seat so that the machine will be under control when the engine starts. Jump starting is a two-person operation.
 - Never use a frozen battery.
 - Failure to follow correct jump starting procedures could result in a battery explosion or a runaway machine.



SA-032

Keep Riders Off Machine

- Riders on machine are subject to injury such as being struck by foreign objects and being thrown off the machine.
 - Riders also obstruct the operator's view, resulting in the machine being operated in an unsafe manner.
 - Only the operator is allowed on the machine. Keep riders off.



SA-1292

SAFETY

Precautions for Operations

- Thoroughly make certain safety at the work site before starting operations. Especially always observe the following points.
 - Be sure to wear close fitting clothing and required safety items, such as a hard hat, when operating the machine.
 - Keep all bystanders and unnecessary objects out of and away from the machine working areas. Always beware of the surroundings while operating the machine. Take care not to allow the rear part of the upperstructure to come in contact with objects when swinging the machine in a small area.
 - When loading a dump truck, bring the bucket from the rear side of the dump truck to avoid moving the bucket over the dump truck cab or over any co-workers.

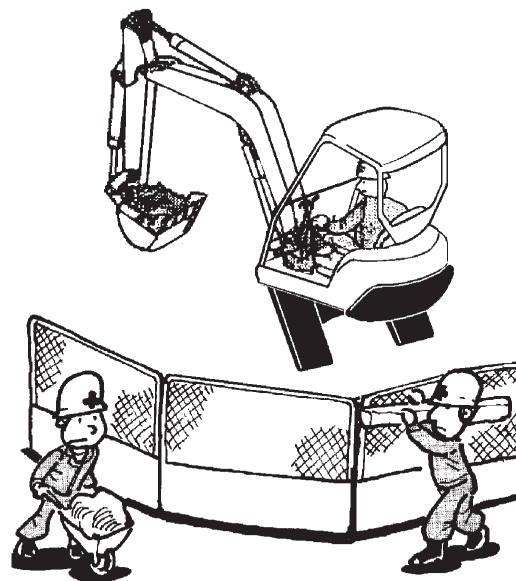

M586-12-012

SAFETY

Investigate Job Site Beforehand

- When working at the edge of an excavation or on a road shoulder, the machine could tip over due to collapse of the ground, possibly resulting in serious injury or death.
 - Investigate the configuration and ground conditions of the job site beforehand to prevent the machine from falling and to prevent the ground, stockpiles, or banks from collapsing.
 - Make a work plan. Use machines appropriate to the work and job site.
 - Reinforce ground, edges, and road shoulders as necessary. Keep the machine well back from the edges of excavations and road shoulders.
 - When working on an incline or on a road shoulder, employ a signal person as required.
 - Never allow bystanders to enter the working area such as swing radius or traveling range.
 - When the footing is weak, reinforce the ground before starting work.
 - When working on frozen ground, be extremely alert. As ambient temperatures rise, footing may become loose and slippery.
 - When operating the machine near open flame, sparks, and/or dead grass, a fire may easily break out. Use special care not to cause a fire.
- Make sure the work site ground has sufficient strength to firmly support the machine. When working close to an excavation or on road shoulders, operate the machine with the tracks positioned perpendicular to the cliff face with travel motors at the rear and with the blade at the front, so that the machine can more easily evacuate if the cliff face collapses.
- If working at the bottom of a cliff or on a high bank is required, be sure to investigate the area first and confirm that no danger of the cliff or bank collapsing exists. If any possibility of cliff or bank collapsing exists, do not work in that area.
- Soft ground may collapse when operating the machine on it, possibly causing the machine to tip over. When working on a soft ground is required, be sure to reinforce the ground first using large pieces of steel plates strong enough and firm to easily support the machine.
- Note that there is always a possibility of machine tipping over when working on rough terrain or on slopes. Prevent machine tipping over from occurring. Operate the machine slowly to ensure safe operation.



SA-1293

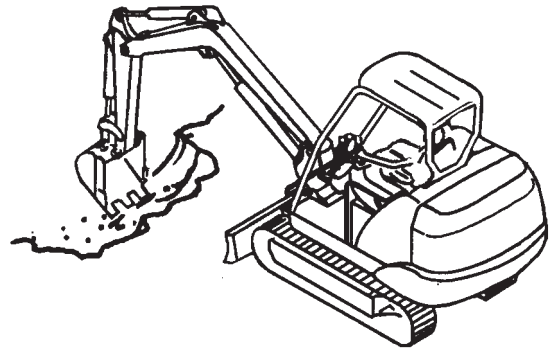

M586-05-021

SAFETY

Equipment of OPG

- In case the machine is operated in areas where the possibility of falling stones or debris exists, equip genuine Hitachi OPG guard. Contact your nearest Hitachi dealer for installation method of the OPG guard. Depending on the specifications applied to your machine, modification of the machine to meet ROPS standards will be possible.
- To maintain unimpaired operator protection and manufacturer's protective structure.
 - Damaged ROPS, OPG guard must be replaced, not repaired or revised.
 - Any alternation to the ROPS or OPG guard must be approved by the manufacturer.

ROPS : Roll Over Protective Structure

OPG : Operator Protective Guard

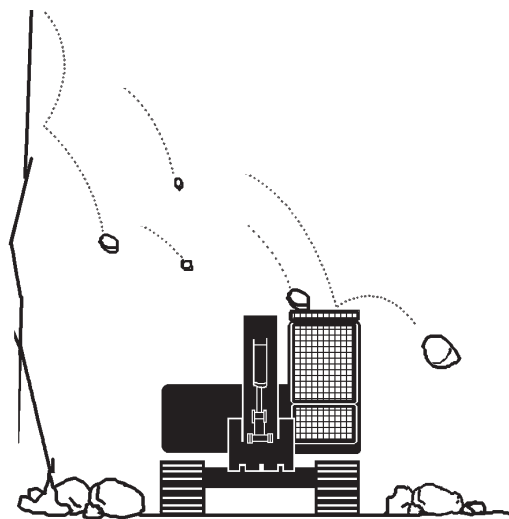

SA-490

Provide Signals for Jobs Involving Multiple Machines

- In case more than one machine is operated in the same job site, accidental collision between machines may cause serious injury or death.
- For jobs involving multiple machines, provide signals commonly known by all personnel involved. Also, appoint a signal person to coordinate the job site. Make sure that all personnel obey the signal person's directions.



SA-481

Confirm Direction of Machine to be Driven

- Incorrect travel pedal/lever operation may result in serious injury or death.
 - Before driving the machine, confirm the position of the undercarriage in relation to the operator's position.
 - If the travel motors are located towards the front of the cab, the machine will move in the reverse direction when travel pedals/levers are operated.

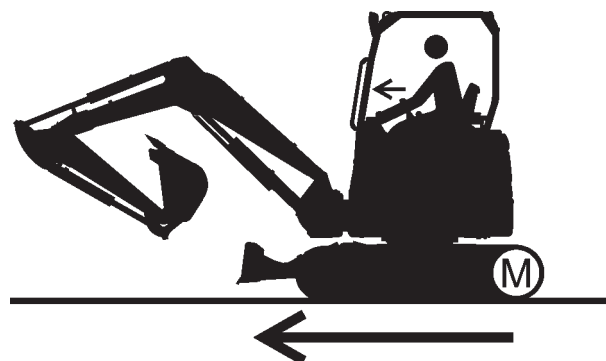

SA-1294

SAFETY

Drive Machine Safely

- Use a signal person when traveling the machine along road shoulders or in congested areas.
- Driving the machine in the incorrect direction may result in serious injury or death and/or severe damage to property.
- Before driving the machine, always confirm that the travel pedals/levers direction corresponds to the direction you wish to drive.
 - Be sure to detour around any obstructions.
 - Avoid traveling over obstructions. Soil, fragments of rocks, and/or metal pieces may scatter around the machine. Do not allow personnel to stay around the machine while traveling.
- Driving on a slope may cause the machine to slip or overturn, possibly resulting in serious injury or death.
 - Never attempt to ascend or descend 30 degrees or steeper slopes.
 - Be sure to fasten the seat belt.
 - When driving up or down a slope, keep the bucket facing the direction of travel, approximately 200 to 300 mm (8 to 12 in) (A) above the ground.
 - If machine starts to skid or becomes unstable, immediately lower the bucket to the ground and stop.
 - Driving across the face of a slope or steering on a slope may cause the machine to skid or turnover. If the direction must be changed, move the machine to level ground, then, change the direction to ensure safe operation.
 - Avoid swinging the upperstructure on slopes. Never attempt to swing the upperstructure downhill. The machine may tip over. If swinging uphill is unavoidable, carefully operate the upperstructure and boom at slow speed.
 - If the engine stalls on a slope, immediately lower the bucket to the ground. Return the control levers to neutral. Then, restart the engine.
 - Be sure to thoroughly warm up the machine before ascending steep slopes. If hydraulic oil has not warmed up sufficiently, sufficient performance may not be obtained.

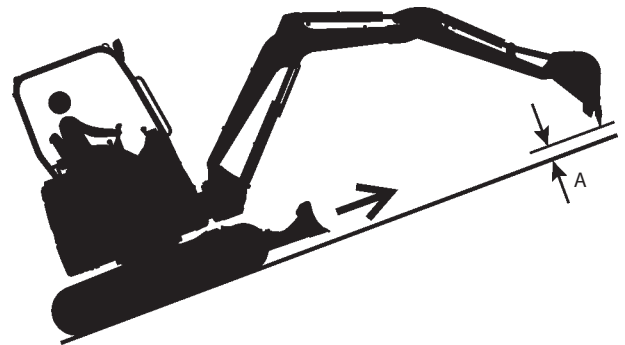

SA-1295

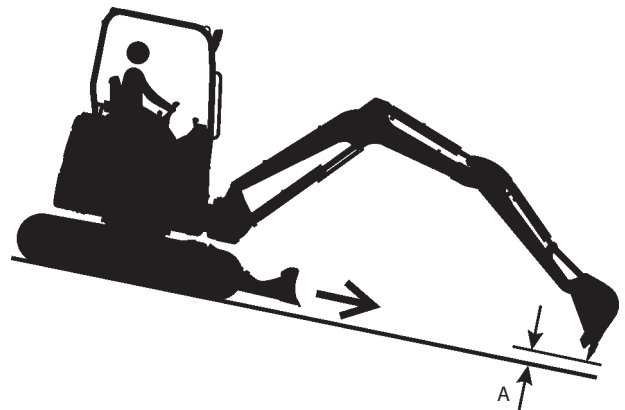

SA-1296

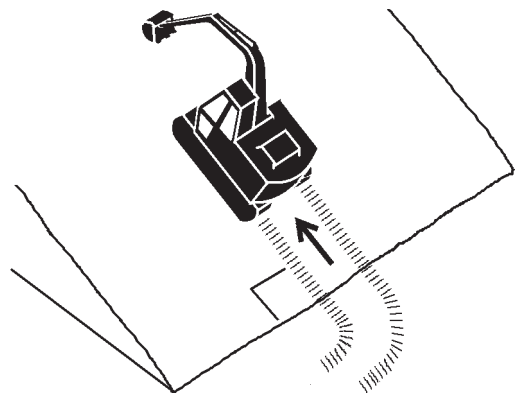

SA-441

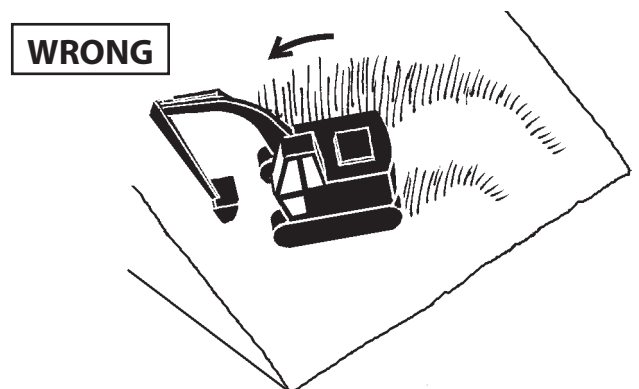

SA-589

SAFETY

- When the machine descends a slope at high speed, machine weight accelerates descending speed. It may cause collision accident due to misjudging of braking distance or machine turnover due to running on an unexpected obstacle.
Always ensure that travel mode display (1) on the monitor is , and then reduce the engine speed before descending a slope.
- Select a travel route that is as flat as possible. Steer the machine as straight as possible, making small gradual changes repeatedly in direction.
- Check the strengths of bridges and road shoulders before traveling on them, and reinforce if necessary.
- When the machine is equipped with steel shoes, cover the road surface with wood plates in order not to damage the road surface. Be careful of steering when operating on asphalt roads in summer.
- When crossing train tracks, lay wood plates over the tracks not to allow the machine to ride on only the rails.
- Check that the machine can pass under a bridge and electric lines before driving the machine.
- When crossing a river, drive the machine slowly while measuring the depth of the river using the bucket. Do not cross the river when the depth of the river is deeper than the upper track shoe surface.
- Reduce the engine speed when traveling on rough terrains. Select a slow travel speed. Slower speed will reduce possible damage to the machine.
- Drive the machine so that the travel motors do not come in contact with loose rocks. If the machine crosses over an obstruction, abnormally large loads may be loaded on the machine. Avoid contact with an obstruction while traveling the machine.
- During freezing weather, always clean snow and ice from track shoes before driving the machine on snowy and/or frozen roads, or loading and unloading the machine for transportation, to prevent the machine from slipping.

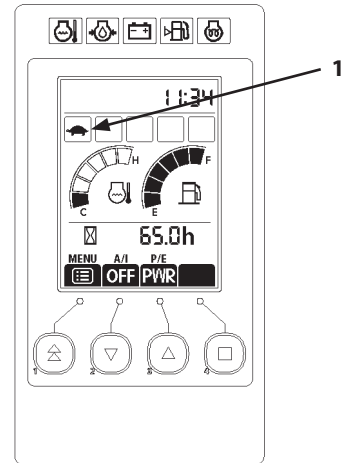

MADB-00-007



M104-05-008

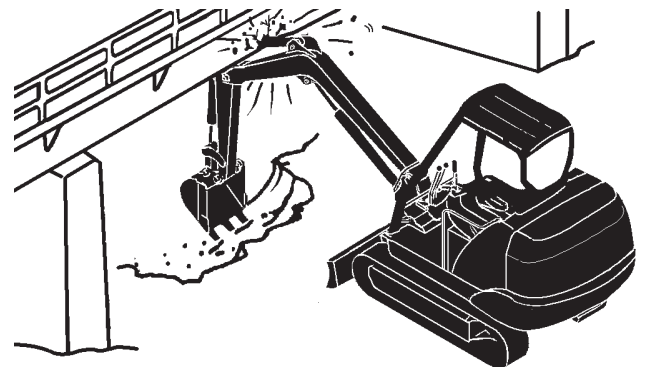

SA-673

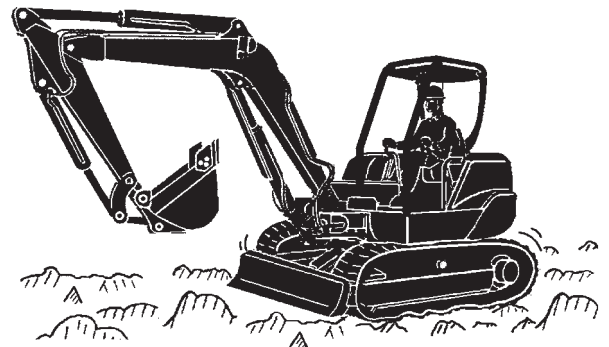

M586-05-002

SAFETY

Avoid Injury From Rollaway Accidents

- Death or serious injury may result if you attempt to mount or try to bodily stop a moving machine.
- Park the machine in compliance with the safe parking procedures described in operator's manual to prevent the machine from running away.
 - Block both tracks and lower the bucket to the ground, thrust the bucket teeth into the ground if you must park on a grade.
 - Park at a reasonable distance from other machines.

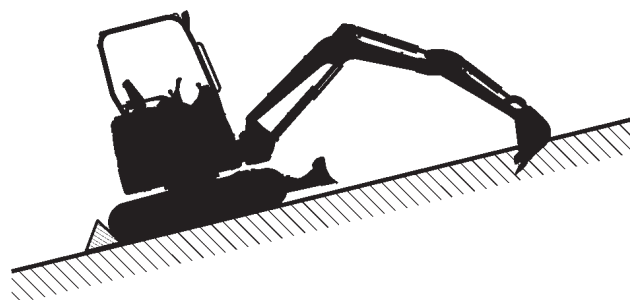

SA-1297

SAFETY

Avoid Injury From Back-over and Swing Accidents

- If any person is present near the machine when backing or swinging the upperstructure, the machine may hit or run over that person, resulting in serious injury or death.

To avoid back-over and swing accidents:

- Always look around BEFORE YOU BACK UP AND SWING THE MACHINE. BE SURE THAT ALL BYSTANDERS ARE CLEAR.
- Keep the travel alarm in working condition (if equipped). ALWAYS BE ALERT FOR BYSTANDERS MOVING INTO THE WORK AREA. USE THE HORN OR OTHER SIGNAL TO WARN BYSTANDERS BEFORE MOVING MACHINE.
- USE A SIGNAL PERSON WHEN BACKING UP IF YOUR VIEW IS OBSTRUCTED. ALWAYS KEEP THE SIGNAL PERSON IN VIEW.

Use hand signals, which conform to your local regulations, when work conditions require a signal person.

- No machine motions shall be made unless signals are clearly understood by both signal person and operator.
- Learn the meanings of all flags, signs, and markings used on the job and confirm who has the responsibility for signaling.
- Keep windows, mirrors, and lights clean and in good condition.
- Dust, heavy rain, fog, etc., can reduce visibility. As visibility decreases, reduce speed and use proper lighting.
- Read and understand all operating instructions in the operator's manual.

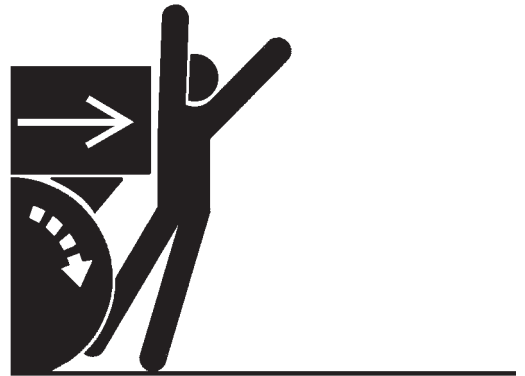

SA-383

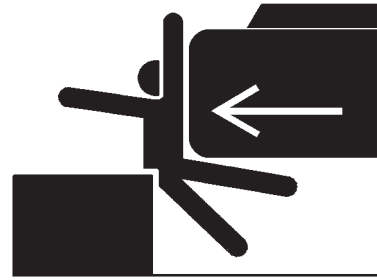

SA-384

SAFETY

Keep Person Clear From Working Area

- If a person is present near the operating machine, the person may come in contact with the swinging front attachment or counterweight and/or may be crushed against an other object, resulting in serious injury or death.
 - Before operating the machine, set up barriers to the sides and rear area of the bucket swing radius to prevent anyone from entering the work area.
 - Make sure that no personnel other than the signal person or no obstacles are present in the working area before operating the machine.

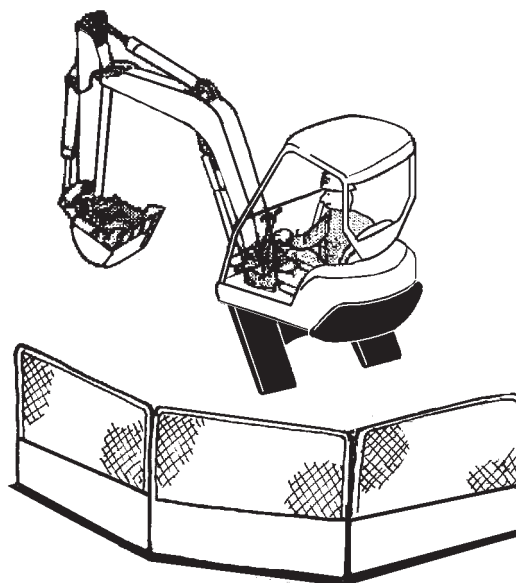

SA-667

Never Position Bucket Over Anyone

- Never lift, move, or swing bucket above anyone or a truck cab. Serious injury or machine damage may result due to bucket load spill or due to collision with the bucket.
 - Never allow the bucket to pass over anyone to avoid personal injury or death.



SA-668

Avoid Undercutting

- In order to retreat from the edge of an excavation if the footing should collapse, always position the undercarriage perpendicular to the edge of the excavation with the travel motors at the rear.
 - If the footing starts to collapse and if retreat is not possible, do not raise the front attachment in a panic. Lowering the front attachment may be safer in most cases.

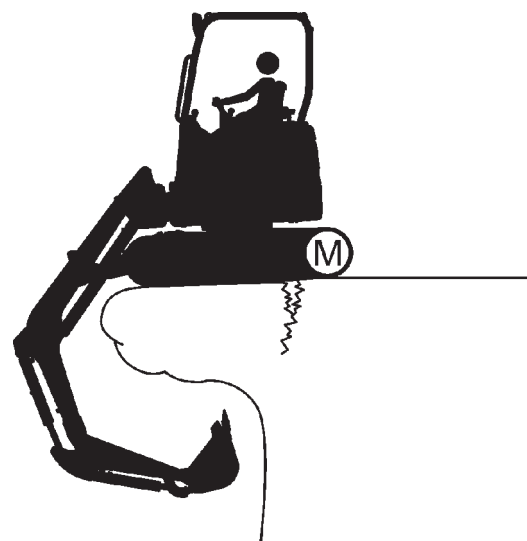

SA-1300

SAFETY

Avoid Tipping

- The danger of tipping is always present when operating on a grade, possibly resulting in serious injury or death.
To avoid tipping:
 - Be extra careful before operating on a grade.
 - Prepare machine operating area flat.
 - Keep the bucket low to the ground and close to the machine.
 - Reduce operating speeds to avoid tipping or slipping.
 - Avoid changing direction when traveling on grades.
 - NEVER attempt to travel across a grade steeper than 15 degrees if crossing the grade is unavoidable.
 - Reduce swing speed as necessary when swinging loads.
- Be careful when working on frozen ground.
 - Temperature increases will cause the ground to become soft and make ground travel unstable.

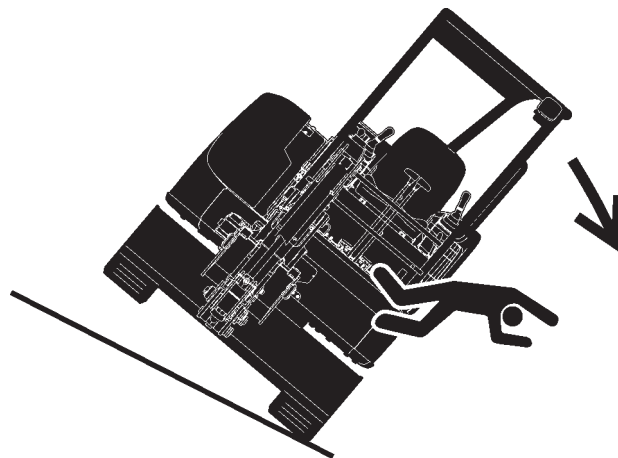

SA-1301

Never Undercut a High Bank

- The edges could collapse or a land slide could occur causing serious injury or death.



SA-1302

SAFETY

Dig With Caution

- Accidental severing of underground cables or gas lines may cause an explosion and/or fire, possibly resulting in serious injury or death.
 - Before digging check the location of cables, gas lines, and water lines.
 - Keep the minimum distance required, by law, from cables, gas lines, and water lines.
 - If a fiber optic cable should be accidentally severed, do not look into the end. Doing so may result in serious eye injury.
 - Contact your local “diggers hot line” if available in your area, and/or the utility companies directly. Have them mark all underground utilities.

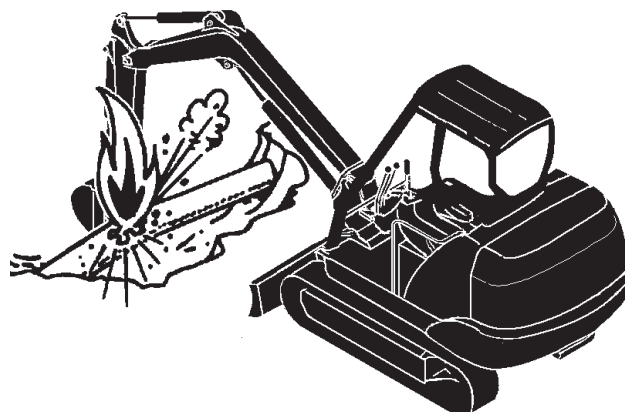

SA-672

Operate With Caution

- If the front attachment or any other part of the machine hits against an overhead obstacle, such as a bridge, both the machine and the overhead obstacle will be damaged, and personal injury may result as well.
 - Take care to avoid hitting overhead obstacles with the boom or arm.

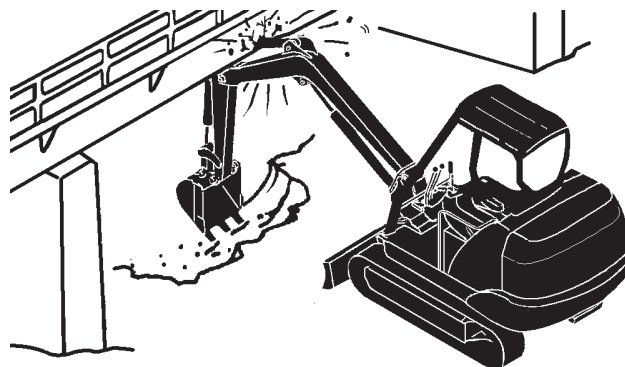

SA-673

Avoid Power Lines

- Serious injury or death can result if the machine or front attachments are not kept a safe distance from electric lines.
 - When operating near an electric line, NEVER move any part of the machine or load closer than 3 m (10 ft) plus twice the line insulator length.
 - Check and comply with any local regulations that may apply.
 - Wet ground will expand the area that could cause any person on it to be affected by electric shock. Keep all bystanders or co-workers away from the site.

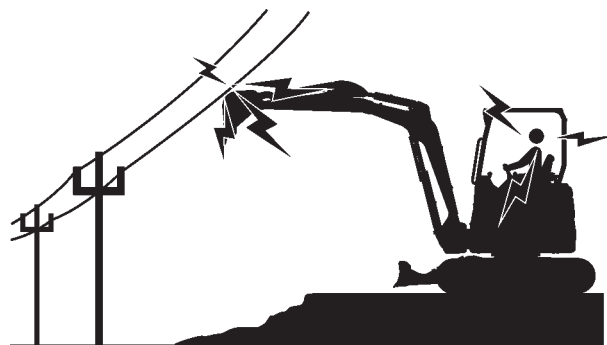

SA-1305

SAFETY

Precautions For Lightning

- The machine is vulnerable to lightning strikes.
 - In the event of an electrical storm, immediately stop operation, and lower the bucket to the ground. Evacuate to a safe place far away from the machine.
 - After the electrical storm has passed, check all of the machine safety devices for any failure. If any failed safety devices are found, operate the machine only after repairing them.



SA-1805

Object Handling

- If a lifted load should fall, any person nearby may be struck by the falling load or may be crushed underneath it, resulting in serious injury or death.
 - When using the machine for craning operations, be sure to comply with all local regulations.
 - Do not use damaged chains or frayed cables, cables, slings, or ropes.
 - Before craning, position the upperstructure with the travel motors at the rear.
 - When using the machine for craning operations, always park the machine on a solid and level ground.
 - Move the load slowly and carefully. Never move it suddenly.
 - Keep all persons well away from the load.
 - Never move a load over a person's head.
 - Do not allow anyone to approach the load until it is safely and securely situated on supporting blocks or on the ground.
 - Never attach a sling or chain to the bucket teeth. They may come off, causing the load to fall.



SA-014

SAFETY

Protect Against Flying Debris

- If flying debris such as soil, rock fragments or metal pieces hit eyes or any other part of the body, serious injury may result.
- Guard against such injuries when working in a job site where possibility of flying pieces of metal or debris exist, or when removing or installing pins using a hammer; wear goggles or safety glasses.
- Keep bystanders away from the working area before striking any object.

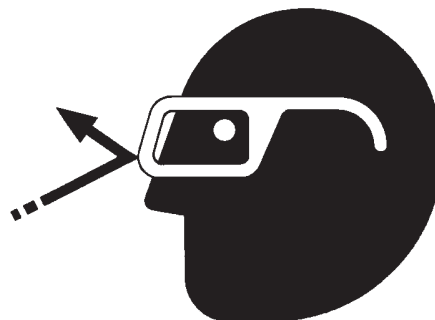

SA-432

Park Machine Safely

- Unless the machine is correctly parked, any hazardous situations such as running away of the machine or damage by vandalism may result, causing the machine to operate unsafely when the engine is restarted. Follow instructions described below when parking the machine.
- Park the machine on solid level surface to prevent the machine from running away.
- Lower the bucket and/or blade to the ground.
- Pull the pilot control shut-off lever to the LOCK position.
- Turn the auto-idle switch OFF. Failure to do so may create a hazardous condition as the engine speed may unexpectedly increase.
- Run the engine at slow idle speed without load for 5 minutes.
- Turn key switch to OFF to stop engine. Remove the key from the key switch.
- Before leaving the machine, close all windows, roof vent, and cab door. Lock all access doors and compartments.



SA-1306

SAFETY

Handle Fluids Safely --- Avoid Fires

- Handle fuel with care; it is highly flammable. If fuel ignites, an explosion and/or a fire may occur, possibly resulting in serious injury or death.
 - Do not refuel the machine while smoking or when near open flame or sparks.
 - Always stop the engine before refueling the machine.
 - Fill the fuel tank outdoors.
- All fuels, most lubricants, and some coolants are flammable.
 - Store flammable fluids well away from fire hazards.
 - Do not incinerate or puncture pressurized containers.
 - Do not store oily rags; they can ignite and burn spontaneously.
 - Securely tighten the fuel and oil filler caps.



SA-018



SA-019

SAFETY

Transport Safely

- The danger of tipping is present when loading/unloading the machine onto/from a truck or trailer bed.
 - Be sure to observe local regulations when transporting the machine on public roads.
 - Provide an appropriate truck or trailer for transporting the machine.
 - Be sure to have a signal person.
 - Take the following precautions when loading/unloading the machine.

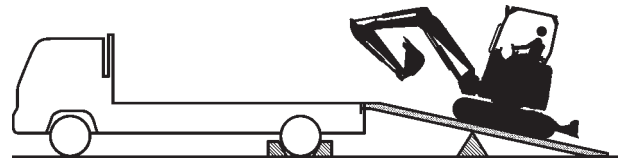

SA-1307

1. Select firm level ground.
2. Be sure to use a loading dock or ramp strong enough to support the machine weight.
3. Ramps must be sufficient in width, length, and strength. Be sure that the incline of the ramp is less than 15 degrees.
4. Loading docks must be sufficient in width and strength to support the machine and have a gradient of less than 15 degrees.
5. Push auto-idle switch (1) to turn A/I display (2) OFF.
6. Select the slow travel mode for loading or unloading the machine.

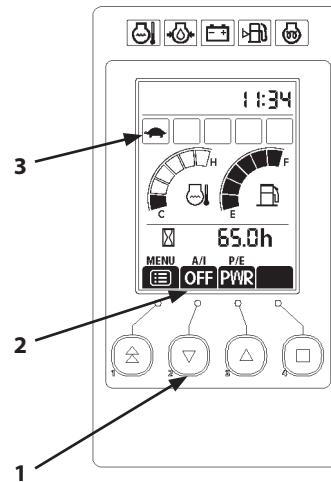

MADB-00-007

Always ensure that travel mode display (3) on the monitor is , before traveling the machine.

7. Avoid steering while driving up or down the ramp as it is extremely dangerous. If steering is unavoidable, first move back to the ground or flatbed, modify traveling direction, and begin to drive again.
8. The top end of the ramp where it meets the flatbed is a sudden bump. Take care when traveling over it.
9. Wedge the front and rear of the tracks. Securely fasten the machine to the trailer bed with chains or cables.
10. Do not operate any levers besides the travel levers when driving up or down the ramp.
11. Prevent possible injury from machine tipping while the upperstructure is rotating.
12. Keep the arm tucked under and rotate the upperstructure slowly for best stability.

Refer to "transporting" chapter in operator's manual for details.

SAFETY

Practice Safe Maintenance

- Inspection/maintenance work may produce hazardous situations by contacting and/or accessing a part of body to a moving, high pressure, and/or high temperature part of the machine. To avoid serious personal injury or death, follow the instructions described below.
 - Thoroughly coordinate the working procedures to be taken hereafter with the co-workers before beginning work such as inspecting/servicing the machine, or replacing the attachment.
 - Safely park the machine in accordance with the instructions for "Park Machine Safely."
 - Keep the work area clean and orderly.
 - Attach a "DO NOT OPERATE" tag in an easy-to-see location such as on a door or a control lever.
 - If moisture permeates into the electrical system, malfunction and/or erroneous movement of the machine may result. Do not clean sensors, cable connectors, and the cab inside using water and/or steam.
 - Wait to begin to work until the engine and hydraulic oil temperatures have cooled down to the safety range.
 - In case inspection/maintenance must be performed with the engine running, be sure to appoint an overseer.
 - Never lubricate or service the machine while moving it.
 - Repair the cracked windowpane before servicing the machine. Failure to do so may cause personal injury.
 - When raising the machine above the ground using the front attachment function, maintain the angle between the boom and the arm in the range of 90 to 110°. Never allow anyone to enter under the machine raised with the front attachment function.
 - In case working under the machine raised above the ground is unavoidably required, securely hold the machine with stays or blocks strong enough to support the machine weight.
 - Never work under the raised bucket.
 - Keep all parts in good condition and properly installed.
 - Always use the specified tools correctly.
 - Always use a clean tool.
 - Fix any damage found immediately. Replace worn or broken parts.
 - Remove any buildup of grease, oil, or debris.
 - When cleaning parts, use a non-combustible cleaning solvent. Never use an inflammable fluid such as diesel fuel, or gasoline.



SA-028

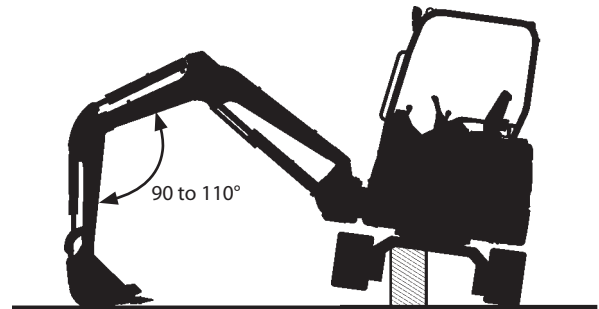

M1M7-04-006



SA-527

SAFETY

- Disconnect battery ground cable (–) before making adjustments to electrical systems or before welding on the machine.
- Sufficiently illuminate the work site. Use a maintenance work light when working under or inside the machine.
- Always use a work light protected with a guard. In case the light bulb is broken, spilled fuel, oil, antifreeze fluid, or window washer fluid may catch fire.
- When the floor tilt mechanism check and/or maintenance is conducted, the operator's station is tilted upward. Before conducting maintenance work, refer to page 7-76 in operator's manual for the detailed operation procedures and correctly operate the machine.
- When required to work under the floor, support the raised operator's station with the fall prevention bars (red color) to ensure safety.
- When the inspection/maintenance work is complete, tilt the operator's station downward after housing the fall prevention bars. Be sure to slowly lower the operator's station at the time.
- Be careful not to allow the operator's station to tilt down without first stowing the fall prevention bars. Damage to the tilt mechanism may result.



SA-037

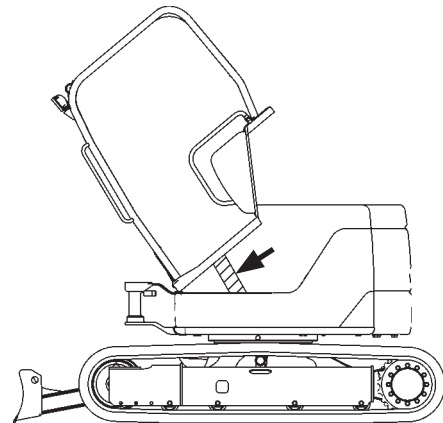

M1MW-07-031

Warn Others of Service Work

- Unexpected machine movement can cause serious injury.
 - Before performing any work on the machine, attach a "Do Not Operate" tag in an easy-to-see place such as on the cab door or control lever.
 - Never attempt to operate the machine with a "Do Not Operate" tag attached.
 - Make it a rule for the inspection/service person to hold the engine start key during inspection/service work.



SS2045102

SAFETY

Support Machine Properly

- Never attempt to work on the machine without securing the machine first.
 - Always lower the attachment to the ground before you work on the machine.
 - If you must work on a lifted machine or attachment, securely support the machine or attachment with stays or blocks strong enough to support the machine and/or attachment weight.



SA-527

Stay Clear of Moving Parts

- Contact with moving parts can cause serious injury or death due to amputation or entanglement.
 - To prevent accidents, care should be taken to ensure that hands, feet, clothing, jewelry and hair do not become entangled when working around rotating parts.

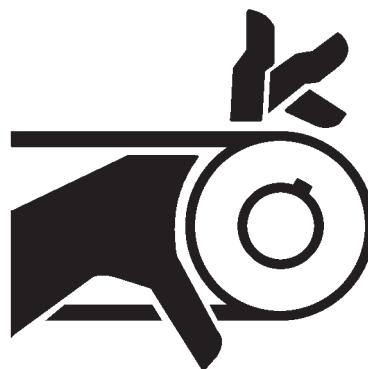

SA-026

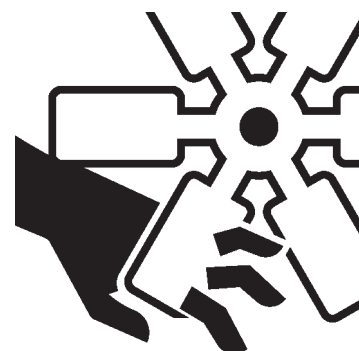

SA-2294

SAFETY

Prevent Parts From Flying

- Grease in the track adjuster is under high pressure. Failure to follow the precautions below may result in serious injury, blindness, or death.
 - Do not attempt to remove GREASE FITTINGS or VALVE ASSEMBLIES.
 - As pieces of parts may fly off, be sure to keep body and face away from the valve.
- Travel reduction gears are under pressure.
 - As pieces of parts may fly off, be sure to keep body and face away from AIR RELEASE PLUG to avoid injury.
 - GEAR OIL is hot. Wait for gear oil to cool, then gradually loosen the air release plug to release pressure.



SA-344

Store Attachments Safely

- Stored attachments such as buckets, hydraulic hammers, and blades can fall and cause serious injury or death.
 - Securely store attachments and implements to prevent falling accidents.
 - Keep children and bystanders away from storage areas.

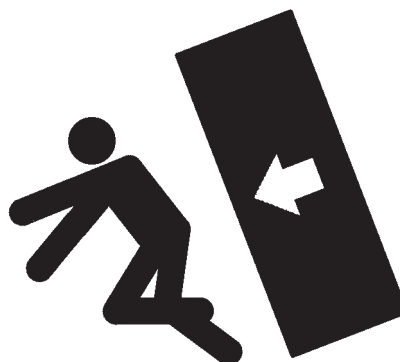

SA-034

SAFETY

Prevent Burns

Hot spraying fluids:

- After operation, engine coolant is hot and under pressure. Hot water or steam is contained in the engine, radiator and heater lines. Skin contact with escaping hot water or steam can cause severe burns.
 - To prevent possible injury from hot spraying water, stop the engine. Begin to work after the engine and radiator are sufficiently cooled
 - DO NOT remove the radiator cap until the engine is cool. When opening, turn the cap slowly to the stop. Allow all pressure to be released before removing the cap.
 - The hydraulic oil tank is pressurized. Again, be sure to release all pressure by slowly removing the cap.



SA-039

Hot fluids and surfaces:

- Engine oil, gear oil and hydraulic oil also becomes hot during operation. The engine, hoses, lines and other parts become hot as well.
 - Wait for the oil and components to cool before starting any maintenance or inspection work.



SA-225

SAFETY

Replace Rubber Hoses Periodically

- Rubber hoses that contain flammable fluids such as hydraulic oil or fuel under pressure may break due to aging, fatigue, and abrasion. It is very difficult to gauge the extent of deterioration due to aging, fatigue, and abrasion of rubber hoses by visual inspection alone.
 - Periodically replace the rubber hoses. (Refer to the Periodical Replacement Parts section in operator's manual.)
- Failure to periodically replace rubber hoses may cause a fire, fluid injection into skin, or the front attachment to fall on a person nearby, which may result in severe burns, gangrene, or otherwise serious injury or death.



SA-019

Avoid High-Pressure Fluids

- Fluids such as diesel fuel or hydraulic oil under pressure can penetrate the skin or eyes causing serious injury, blindness or death.
 - Avoid this hazard by relieving pressure before disconnecting hydraulic or other lines. Make sure that all connectors are completely connected before applying pressure.
 - Search for leaks with a piece of cardboard; take care to protect hands and body from high-pressure fluids. Wear a face shield or goggles for eye protection.
 - If an accident occurs, see a doctor familiar with this type of injury immediately. Any fluid injected into the skin must be surgically removed within a few hours, or gangrene may result.



SA-031

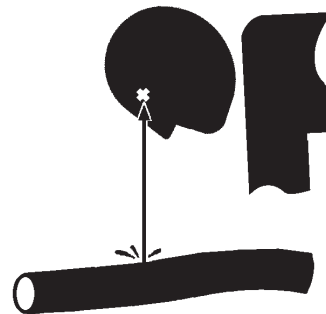

SA-292

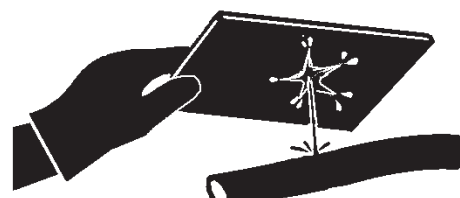

SA-044

SAFETY

Prevent Fires

Check for Oil Leaks:

- Fuel, hydraulic oil and lubricant leaks can lead to fires, possibly resulting in personal injury or death.
 - Check for missing or loose clamps, kinked hoses, lines or hoses that rub against each other, damage to the oil-cooler, and loose oil-cooler flange bolts, for oil leaks.
 - Tighten, repair or replace any missing, loose or damaged clamps, lines, hoses, oil-cooler and oil-cooler flange bolts.
 - Do not bend or strike high-pressure lines.
 - Never install bent or damaged lines, pipes or hoses.



Check for Shorts:

SA-019

- Short circuits can cause fires.
 - Clean and tighten all electrical connections.
 - Check before each shift or after eight (8) to ten (10) hours operation for loose, kinked, hardened or frayed electrical cables and wires.
 - Check before each shift or after eight (8) to ten (10) hours operation for missing or damaged terminal caps.
 - DO NOT OPERATE MACHINE if cable or wires are loose, kinked, etc.

Precautions for Handling Flammables

- Spilled fuel and oil, and trash, grease, debris, accumulated coal dust, and other flammables may cause fires.
 - Prevent fires by inspecting and cleaning the machine daily, and by removing spilled or accumulated flammables immediately.
 - Do not store flammable fluid near open flames.
 - Do not burn or crush a pressurized container.
 - Do not store oily cloths. They are liable to catch fire.
 - Do not wind easy-to-absorb-oil material around high-temperature parts such as a muffler or exhaust pipe.

SAFETY

Clean up Flammables:

- Spilled fuel and oil, and trash, grease, debris, accumulated coal dust, and other flammables may cause fires.
 - Prevent fires by inspecting and cleaning the machine daily, and by removing adhered oil or accumulated flammables immediately. Check and clean high temperature parts such as the exhaust outlet and mufflers earlier than the normal interval.
 - Do not wrap high temperature parts such as a muffler or exhaust pipe with oil absorbents.
 - Do not store oily cloths as they are vulnerable to catching fire.
 - Keep flammables away from open flames.
 - Do not ignite or crush a pressurized or sealed container.
 - Wire screens may be provided on openings on the engine compartment covers to prevent flammables such as dead leaves from entering. However, flammables which have passed through the wire screen may cause fires. Check and clean the machine every day and immediately remove accumulated flammables.

Check Heat Shield Covers around Engine Compartment

- If the engine compartment heat shield cover becomes broken or lost, fire may break out.
 - If the engine compartment heat shield cover becomes broken or lost, repair or replace it before operating the machine.

Check Key Switch:

- If fire breaks out, failure to stop the engine will escalate the fire, hampering fire fighting.
 - Always check key switch function before operating the machine every day:
 - 1) Start the engine and run it at slow idle.
 - 2) Turn the key switch to the OFF position to confirm that the engine has stopped.
 - If any abnormalities are found, be sure to repair them before operating the machine.

SAFETY

Evacuating in Case of Fire

- If fire breaks out during machine operation, evacuate the machine in the following way:
 - Stop the engine by turning the key switch to the OFF position.
 - Use a fire extinguisher if there is time.
 - Exit the machine using handrails and/or steps.
 - In an emergency, if the cab door or front or rear window can not be opened, break the front or rear window panes with the emergency evacuation hammer to escape from the cab.

Refer to the explanation pages on the Emergency Exit.



SA-393



SS-1510

Beware of Exhaust Fumes

- Prevent asphyxiation. Engine exhaust fumes can cause sickness or death.
 - If you must operate the machine in a building, be sure there is adequate ventilation. Either use an exhaust pipe extension to remove the exhaust fumes or open doors and windows to bring enough outside air into the area.

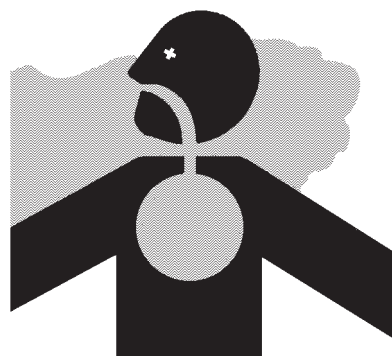

SA-016

SAFETY

Precautions for Welding and Grinding

- Welding may generate gas and/or small fires.
 - Be sure to perform welding in a well ventilated and prepared area. Store flammable objects in a safe place before starting welding.
 - Only qualified personnel should perform welding. Never allow an unqualified person to perform welding.
- Grinding on the machine may create a fire hazard. Store flammable objects in a safe place before starting grinding.
- After finishing welding and grinding, recheck that there are no abnormalities such as the area surrounding the welded area still smoldering.



SA-818

Avoid Heating Near Pressurized Fluid Lines

- Flammable spray can be generated by heating near pressurized fluid lines, resulting in severe burns to yourself and bystanders.
 - Do not heat by welding, soldering, or using a torch near pressurized fluid lines or other flammable materials.
 - Pressurized lines can be accidentally cut when heat goes beyond the immediate flame area. Install temporary fire resistant guards to protect hoses or other materials before engaging in welding, soldering, etc.



SA-030

Avoid Applying Heat to Lines Containing Flammable Fluids

- Do not weld or flame cut pipes or tubes that contain flammable fluids.
- Remove flammable fluids thoroughly with nonflammable solvent before welding or flame cutting pipes or tubes that contained flammable fluids.

Precautions for Handling Accumulator and Gas Damper

High-pressure nitrogen gas is sealed in the accumulator and the gas damper. Inappropriate handling may cause explosion, possibly resulting in serious injury or death.

Strictly comply with the following items: Do not disassemble the unit.

- Keep the units away from open flames and fire.
- Do not bore a hole, do not cut by torch.
- Avoid giving shocks by hitting or rolling the unit.
- Before disposing the unit, sealed gas must be released. Consult your nearest Hitachi dealer.

SAFETY

Remove Paint Before Welding or Heating

- Hazardous fumes can be generated when paint is heated by welding, soldering, or using a torch. If inhaled, these fumes may cause sickness.
 - Remove paint before welding or heating.
 - Avoid potentially toxic fumes and dust.
 - Do all such work outside or in a well-ventilated area. Dispose of paint and solvent properly.
 - Allow fumes to disperse at least 15 minutes after welding or heating.
 - Use attention to the following points when removing paint.
 1. If you sand or grind paint, avoid breathing the dust which is created.

Wear an approved respirator.
 2. If you use solvent or paint stripper, remove stripper with soap and water before welding.
 3. Remove solvent or paint stripper containers and other flammable material from area.



SA-029

Beware of Asbestos and Silicon Dust and Other Contamination

- Take care not to inhale dust produced in the work site. Inhalation of asbestos fibers may be the cause of lung cancer. Inhalation of silicon dust and other contamination may cause sickness.
 - Depending on the work site conditions, the risk of inhaling asbestos fiber, silicon dust or other contamination may exist. Spray water to prevent asbestos, silicon dust or other contamination from airborne. Do not use compressed air.
 - When operating the machine in a work site where asbestos, silicon dust or other contamination might be present, be sure to operate the machine from the upwind side and wear a mask rated to prevent the inhalation of asbestos, silicon dust or other contamination.
 - Keep bystanders out of the work site during operation.
 - Asbestos might be present in imitation parts. Use only genuine Hitachi Parts.



SA-029

SAFETY

Prevent Battery Explosions

- Battery gas can explode.
 - Keep sparks, lighted matches, and flame away from the top of battery.
 - Never check battery charge by placing a metal object across the posts. Use a voltmeter or hydrometer.
 - Do not charge a frozen battery; it may explode. Warm the battery to 16 °C (60 °F) first.
 - Do not continue to use or charge the battery when the electrolyte level is lower than specified. Explosion of the battery may result.
 - When a terminal becomes loose, it may induce sparks. Securely tighten all terminals.
 - Connect terminals to the correct electrical poles. Failure to do so may cause damage to the electrical parts or fire.
- Battery electrolyte is poisonous. If the battery should explode battery electrolyte may be splashed into eyes, possibly resulting in blindness. If electrolyte is splashed into eyes, flush your eyes continuously with water for about 15 minutes. Seek medical attention immediately.
 - Be sure to wear eye protection when checking electrolyte specific gravity.



SA-032

Precautions for Handling Refrigerant

- If refrigerant is splashed into eyes or spilled onto skin, blindness or a cold contact burn may result.
 - Refer to the precautions described on the refrigerant container for handling refrigerant.
 - Use a recovery and recycling system to avoid venting refrigerant into the atmosphere.
 - Never allow the skin to directly come in contact with refrigerant.



SA-405

SAFETY

Handle Chemical Products Safely

- Direct exposure to hazardous chemicals can cause serious injury. Potentially hazardous chemicals used with your machine include such items as lubricants, electrolyte, coolants, paints, and adhesives.
- A Material Safety Data Sheet (MSDS) provides specific details on chemical products: physical and health hazards, safety procedures, and emergency response techniques.
- Check the MSDS before you start any job using a hazardous chemical. Then follow the correct procedures and use recommended equipment.
- See your authorized dealer for MSDS.



SA-309

Dispose of Waste Properly

- Improperly disposing of waste can threaten the environment and ecology. Potentially harmful waste used with HITACHI equipment includes such items as oil, fuel, coolant, brake fluid, filters, and battery.
- When draining fluid, use a leakproof container with a capacity larger than the drained fluid volume to receive it.
- Do not pour waste onto the ground, down a drain, or into any water source.
- Inquire on the proper way to dispose of harmful waste such as oil, fuel, coolant, brake fluid, filters, and battery from your local environmental or recycling center.

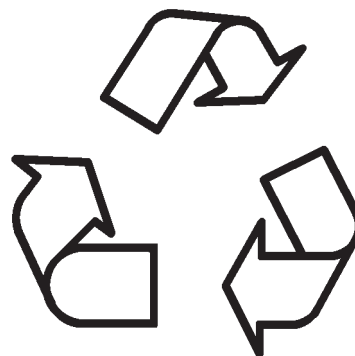

SA-226

SAFETY

Never Ride Attachment

- Never allow anyone to ride attachments or the load. This is an extremely dangerous practice.

Precautions for Communication Terminal

Electrical wave transmitted from the communication terminal may cause malfunction of other electronic devices. Inquire the device manufacturer for electrical wave disturbance upon using an electronic device near the communication terminal.

SAFETY

Precaution for Communication Terminal Equipment

A mobile communication terminal which transmits radio wave is located in the monitor cover at front right of the operator's seat. There is a possibility that a medical device, including an implantable device such as a cardiac pacemaker, would be affected and would malfunction by the electrical waves emitted from the communication terminal equipment.

A person who is using a medical device should adjust the operator's seat before operating the machine so that the distance from the monitor cover with the communication terminal mentioned above to the medical device is 22 centimeters (8.662 inches) or longer. If such condition cannot be met, please contact our company's nearest dealer and have the person in charge stop the communication terminal equipment from functioning completely and confirm that it is not emitting electrical waves.

Specific Absorption Rate ("SAR") (measured by 10 g per unit) of communication terminal equipments:

E-GSM900	0.573 W/Kg (914.80 MHz)
DCS-1800	0.130 W/Kg (1710.20 MHz)
WCDMA Band I	0.271 W/Kg (1950.00 MHz)

*This data was measured by having each type of communication terminal equipment, such as the communication terminal equipment used with this machine, and a human body set apart by 3 cm (1.18 inches).

* SAR is a measure of the amount of radio frequency energy absorbed by the body when using a wireless application such as a mobile phone.

In Japan: *Under the Japanese Radio Act and other relevant Japanese regulations, the maximum SAR value is 2 W/kg (as of March 2012).

In EU Member nation: *Under the "Council Recommendation 1999/519/EC 12 July 1999"; the maximum SAR value is 2 W/kg (as of March 2010).

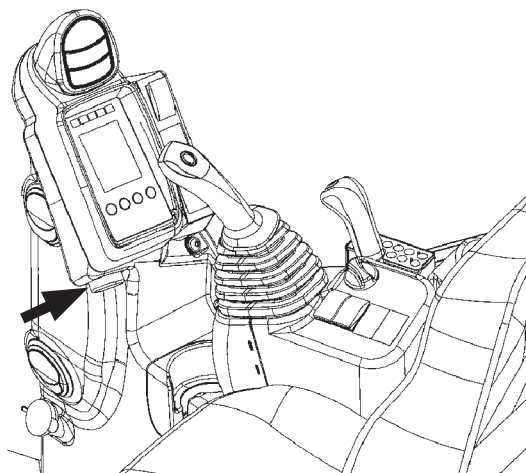

MADB-00-008

SAFETY

- Never attempt to disassemble, repair, modify or displace the communication terminal, antennas or cables. Failure to do so may result in damage and/or fire to the base machine or to the communication terminal. (When required to remove or install the communication terminal, consult your nearest Hitachi dealer.)
- Do not pinch or forcibly pull cables, cords or connectors. Failure to do so may cause short circuit or broke circuit that may result in damage and/or fire to the base machine or to the communication terminal.

Before Returning the Machine to the Customer

- After maintenance or repair work is complete, confirm that:
 - The machine is functioning properly, especially the safety systems.
 - Worn or damaged parts have been repaired or replaced.



SA-435

SECTION AND GROUP CONTENTS

WORKSHOP MANUAL

SECTION 1 GENERAL

Group 1 Precautions for Disassembling and Assembling
--

Group 2 Tightening

Group 3 Painting

Group 4 Bleeding Air

Group 5 Pressure Release Procedure

Group 6 Preparation

Group 7 Connect The Hose

SECTION 2 MAINTENANCE STANDARD

Group 1 Upperstructure

Group 2 Undercarrlage

Group 3 Front Attachment

SECTION 3 UPPERSTRUCTURE

Group 1 Canopy and Cab

Group 2 Counterweight

Group 5 Pump Device

Group 6 Control Valve

Group 7 Swing Device

Group 8 Pilot Valve

Group 9 Solenoid Valve

SECTION 4 UNDERCARRIAGE

Group 1 Swing Bearing

Group 2 Travel Device

Group 3 Center Joint

Group 4 Track Adjuster

Group 5 Front Idler

Group 6 Upper and Lower Roller

Group 7 Track

Group 8 Blade Cylinder

SECTION 5 FRONT ATTACHMENT

Group 1 Front Attachment

Group 2 Cylinder

All information, illustrations and specifications in this manual are based on the latest product information available at the time of publication. The right is reserved to make changes at any time without notice.

TECHNICAL MANUAL

SECTION 1 GENERAL

- Group 1 Specification
- Group 2 Component Layout
- Group 3 Component Specifications

SECTION 2 SYSTEM

- Group 1 Hydraulic System
- Group 2 Electrical System

SECTION 3 COMPONENT OPERATION

- Group 1 Pump Device
- Group 2 Swing Device
- Group 3 Control Valve
- Group 4 Pilot Valve
- Group 5 Travel Device
- Group 6 Others (Upperstructure)
- Group 7 Others (Undercarriage)

SECTION 4 OPERATIONAL PERFORMANCE TEST

- Group 1 Introduction
- Group 2 Standard
- Group 3 Engine Test
- Group 4 Machine Performance Test
- Group 5 Component Test
- Group 6 Adjustment

SECTION 5 TROUBLESHOOTING

- Group 1 Diagnosing Procedure
 - Group 2 Troubleshooting A
 - Group 3 Troubleshooting B
-

SECTION 1

GENERAL

CONTENTS

Group 1 Precautions for Disassembling and Assembling

Precautions for Disassembling and Assembling.....W1-1-1-1

Group 2 Tightening

Tightening Bolts and Nuts.....W1-2-1-1
Piping JointW1-2-1-4

Group 3 Painting

PaintingW1-3-1-1

Group 4 Bleeding Air

Bleeding Air from Hydraulic Oil Tank.....W1-4-1-1
Bleeding Air from Hydraulic SystemW1-4-1-2
Bleeding Air from Fuel SystemW1-4-1-3
Bleeding Air from RadiatorW1-4-1-4

Group 5 Releasing Pressure

Releasing Pressure in Hydraulic Circuit.....W1-5-1-1

Group 6 Preparation

Preparation before Inspection and MaintenanceW1-6-1-1

Group 7 Connect The Hose

Angle to connect the hoseW1-7-1-1

(Blank)

SECTION 1 GENERAL

Group 1 Precautions for Disassembling and Assembling

Precautions for Disassembling and Assembling

Precautions for Disassembling

- **Clean the Machine**
Thoroughly wash the machine before bringing it into the shop. Bringing a dirty machine into the shop may cause machine components to be contaminated during disassembling / assembling, resulting in damage to machine components, as well as decreased efficiency in service work.
- **Inspect the Machine**
Be sure to thoroughly understand all disassembling / assembling procedures beforehand to help avoid incorrect disassembling of components as well as personal injury.
Check and record the items listed below to prevent problems from occurring in the future.
 - The machine model, machine serial number, and hour meter reading.
 - Reason for disassembly (symptoms, failed parts, and causes).
 - Clogging of filters and oil, water or air leaks, if any. Capacities and condition of lubricants.
 - Loose or damaged parts.
- **Prepare and Clean Tools and Disassembly Area**
Prepare the necessary tools to be used and the area for disassembling work.

Precautions for Disassembling and Assembling

- **Precautions for Disassembling**
 - Cap the open ends in case the hoses and pipes have been disconnected. In addition, attach an identification tag onto the connectors, hoses, and pipes for assembling.
 - Before disassembling, clean the exterior of the components and place on a workbench.
 - Drain hydraulic oil and gear oil from the hydraulic components and reduction gear.
 - Be sure to provide appropriate containers for draining fluids.
 - Use matching marks for easier reassembling if necessary.
 - Be sure to use the specified special tools when instructed.

- If a part or component cannot be removed after removing its securing nuts and bolts, do not attempt to remove it forcibly. Find the cause (s), then take the appropriate measures to remove it.
 - Orderly arrange disassembled parts. Mark and tag them if necessary.
 - Store common parts, such as bolts and nuts with reference to where they are to be used and in a manner that will prevent loss.
 - Inspect the contact or sliding surfaces of disassembled parts for abnormal wear, sticking, or other damage.
 - Measure and record the degree of wear and clearances.
- **Precautions for Assembling**
 - Be sure to clean all parts and inspect them for any damage. If any damage is found, repair or replace part.
 - Dirt or debris on the contact or sliding surfaces may shorten the service life of the machine. Take care not to contaminate any contact or sliding surfaces.
 - Apply appropriate lubricant oil onto parts in order to prevent them from seizing.
 - Be sure to replace O-rings, backup rings, oil seals, and floating seals with new ones once they have been disassembled. Apply grease before installing
 - Be sure that liquid-gasket-applied surfaces are clean and dry.
 - If an anti-corrosive agent has been used on a new part, be sure to thoroughly clean the part to remove the agent.
 - Fit the matching marks made when disassembling and assemble them.
 - Be sure to use the designated tools to assemble bearings, bushings, and oil seals.
 - Keep a record of the number of tools used for disassembly / assembly. After assembling is completed, count the number of tools so as to make sure that no forgotten tools remain in the assembled machine.

SECTION 1 GENERAL

Group 1 Precautions for Disassembling and Assembling

Precautions for Using Floating Seal

1. In general, replace the floating seal with a new one after disassembling.

If the floating seal is required to be reused, follow these procedures:

- Keep seal rings together as a matched set with seal ring (1) surfaces together. Apply oil onto sliding surface (e) of seal ring (1).
- Check sliding surface (e) of seal ring (1) for scuffing, scoring, corrosion, deformation, or uneven wear. Check the step part of seal ring (1).
- Check O-ring (2) for tears, breaks, deformation, or hardening.

2. If incorrectly assembled, oil leakage or damage will occur. Be sure to do the following to prevent trouble.

- Clean the floating seal and seal mounting bores with cleaning solvent.

Use a wire brush to remove mud, rust, or dirt from seal mounting bores. After cleaning, thoroughly dry parts with compressed air.

- Clean seal ring (1) and O-ring (2) mounting bores. Check the bore surface for scuffing or scoring by touching the surface with finger.
- After installing the floating seal, check that O-ring (2) is not twisted, and that it is installed correctly on seal ring (1).
- After installing the floating seal, check that O-ring (2) and seal ring sliding surface (e) is parallel with seal mating surface (f) by measuring the distances (e) and (f) at point (A) and (B), as illustrated. If these distances differ, correct O-ring (2) seating.

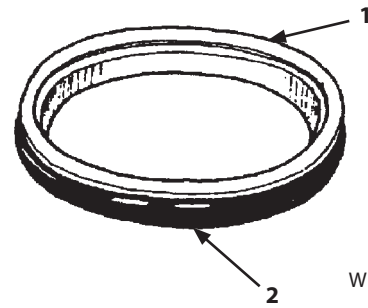

W178-02-11-001

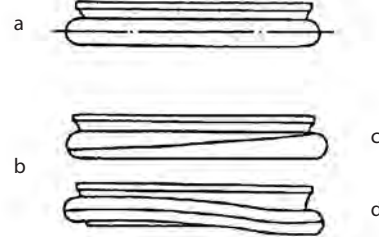
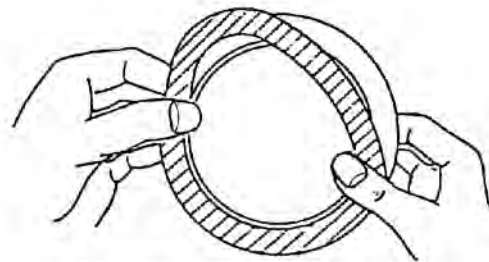

W178-02-11-002

- a - Correct
- b - Incorrect
- c - Twist of O-Ring
- d - Bend of O-Ring

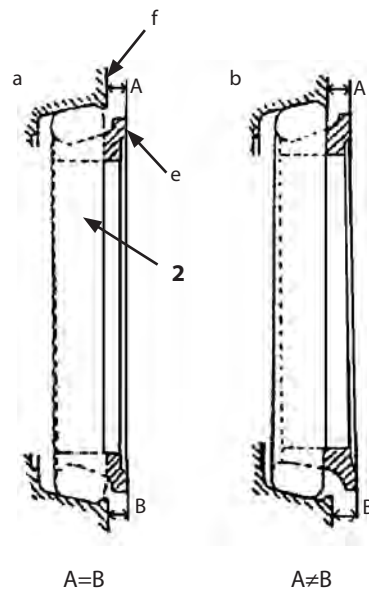

W178-02-11-003

- a - Correct
- b - Incorrect
- e - Sliding Surface
- f - Seal Mating Surface

SECTION 1 GENERAL

Group 1 Precautions for Disassembling and Assembling

Precautions for Using Nylon Sling

1. Follow the precautions below to use nylon slings safely.
 - Attach protectors (soft material) on the corners of the load so that the nylon sling does not directly contact the corners. This will prevent the nylon sling from being damaged and the lifted load from slipping.
 - Lower the temperature of the lifted load to lower than 100 °C (212 °F). If unavoidably lifting a load with a temperature of 100 °C (212 °F) or more, reduce the load weight.
 - Do not lift acid or alkali chemicals.
 - Take care not to allow the sling to become wet. The load may slip.
 - When required to use more than one sling, use slings with the same width and length to keep the lifted load balanced.
 - When lifting a load using an eyehole, be sure to eliminate any gaps between the sling and load. (Refer to the right illustration.) Reduce the load weight so that it is less than 80 % of the sling breaking force.
 - Avoid using twisted, bound, connected, or hitched slings.
 - Do not place any object on twisted or bent slings. (Refer to the right illustration.)
 - When removing the slings from under the load, take care not to damage the nylon slings. Avoid contact with protrusions.
 - Avoid dragging slings on the ground, throwing slings, or pushing slings with a metal object.
 - When using with other types of slings (wire rope) or accessories (shackle), protect the joint so that the nylon sling is not damaged.
 - Store the nylon slings indoors so that they won't deteriorate with heat, sun light, or chemicals.

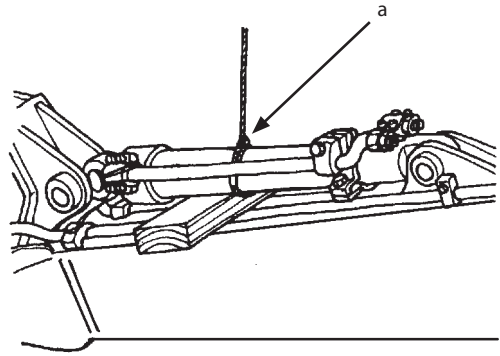

W102-04-02-016

a - Correct Eyehole Lifting Method

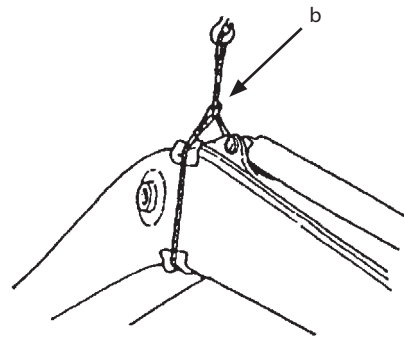

W105-04-01-008

b - Incorrect Eyehole Lifting Method

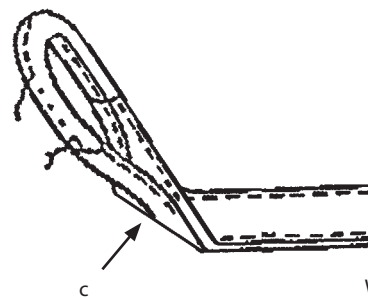

W162-01-01-009

c - Bent of Sling

SECTION 1 GENERAL

Group 1 Precautions for Disassembling and Assembling

CAUTION: If a load is lifted with a damaged nylon sling, serious personal injury may result. Be sure to visually check the nylon sling for any damage before using.

- Before using a nylon sling, visually check the nylon sling for any damage corresponding to examples shown to the right. If any damage is found, cut and discard the sling. Even if no damage is found, do not use slings older than 7 years.

Damaged Appearance

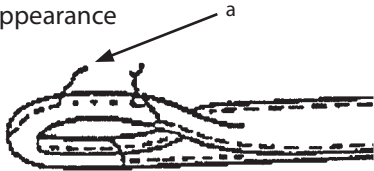

W162-01-01-002

a - Broken Sewing Thread

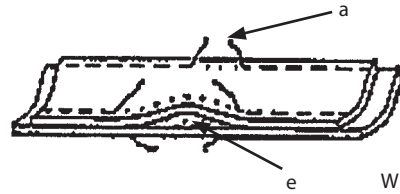

W162-01-01-006

a - Broken Sewing Thread e - Separation of Belt



W162-01-01-003

b - Scuffing

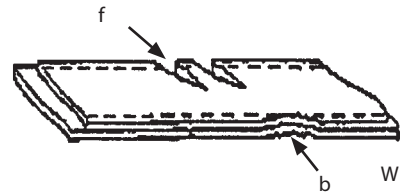

W162-01-01-007

b - Scuffing f - Scoring

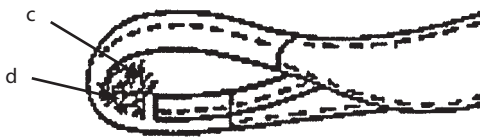

W162-01-01-004

c - Fuzz d - Broken Sewing Thread

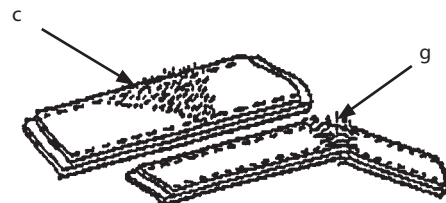

W162-01-01-008

c - Fuzz g - Broken Warp



W162-01-01-005

a - Broken Sewing Thread

SECTION 1 GENERAL

Group 1 Precautions for Disassembling and Assembling

Maintenance Standard Terminology

“Standard”

1. Dimension for parts on a new machine.
2. Dimension of new components or assemblies adjusted to specification. Allowable errors will be indicated if necessary.

“Allowable Limit”

1. Normal machine performance cannot be accomplished after exceeding this limit.
2. Repair or adjustment is difficult after exceeding this limit.
3. Repair or adjustment is impossible after exceeding this limit.
Therefore, in consideration of operation efficiency and maintenance expense, proper maintenance shall be carried out before reaching the “Allowable Limit”.

SECTION 1 GENERAL
Group 1 Precautions for Disassembling and Assembling

(Blank)

SECTION 1 GENERAL

Group 2 Tightening

Tightening Bolts and Nuts

CAUTION: Use tools appropriate for the work to be done. Makeshift tools and procedures can create safety hazards. For loosening and tightening nuts and bolts, use correct size tools. Otherwise, tightening tools may slip, potentially causing personal injury.



IMPORTANT:

- Apply lubricant to the bolts and nuts in order to reduce friction coefficient of them. (For example, spindle oil with white zinc B dissolved in it)
- Clean the bolt and nut threads and remove dirt or corrosion before installing.

WDAA-01-02-001

Bolt Types

Tighten the nuts or bolts correctly to the torque specifications.
As the different types and grades of bolt are used, use and tighten the correct bolts correctly when assembling the machine or components.

Specified Tightening Torque Chart

2013/09

Bolt Dia. mm	Hexagon Head Bolt						Socket Bolt			
	 WDAA-01-02-002		 WDAA-01-02-003		 WDAA-01-02-004		Wrench Size mm	Socket Bolt		Wrench Size mm
	N·m	(lbf·ft)	N·m	(lbf·ft)	N·m	(lbf·ft)		N·m	(lbf·ft)	
6					3 to 4	(2.2 to 3)	10			5
8	30	(22)	20	(15)	10	(7.4)	13	20	(15)	6
10	65	(48)	50	(37)	20	(15)	17	50	(37)	8
12	110	(81)	90	(66)	35	(26)	19	90	(66)	10
14	180	(133)	140	(103)	55	(41)	22	140	(103)	12
16	270	(200)	210	(155)	80	(59)	24	210	(155)	14
18	400	(300)	300	(220)	120	(89)	27	300	(220)	14
20	550	(410)	400	(300)	170	(125)	30	400	(300)	17
22	750	(550)	550	(410)	220	(162)	32			
24	950	(700)	700	(520)	280	(205)	36			
27	1400	(1030)	1050	(770)	400	(300)	41			
30	1950	(1440)	1450	(1070)	550	(410)	46			
33	2600	(1920)	1950	(1440)	750	(550)	50			
36	3200	(2360)	2450	(1810)	950	(700)	55			

SECTION 1 GENERAL

Group 2 Tightening

IMPORTANT: The following items are applied to both fine and coarse pitch threads.

- Apply lubricant to the bolts and nuts in order to reduce friction coefficient of them. (For example, spindle oil with white zinc B dissolved in it)
- Torque tolerance is $\pm 10\%$.
- Use the bolts of correct length. The bolts that are too long cannot be tightened as the bolt tip comes into contact with the bottom of bolt hole. Also the bolts that are too short cannot develop sufficient tightening force.
- The torque given in the chart on the previous page are for general use only, however, a different torque is given for a specific application. Use the specified torque.
- Clean the nut and bolt threads and remove dirt or corrosion before installing.

Tightening Order

When tightening two or more bolts, tighten them alternately, as shown, to ensure even tightening.

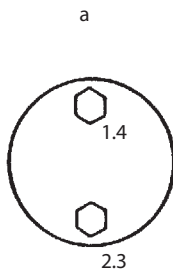

a - Equally tighten upper and lower alternately

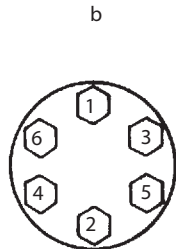

b - Tighten diagonally

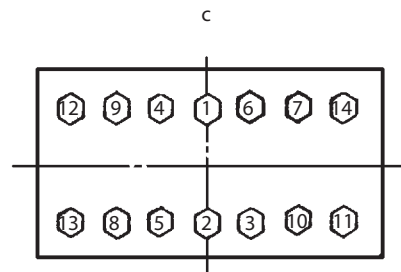

c - Tighten from center diagonally

W105-01-01-003

SECTION 1 GENERAL

Group 2 Tightening

Precautions for Spilt Flange

IMPORTANT:

- Clean the sealing surfaces. Check if there are any scratches and roughness on the surface of the seal that cause oil leaks and damage to the O-ring.
- Use only specified O-rings. Inspect O-rings for any damage. Do not file the O-ring surfaces. When installing O-ring into a groove, use grease in order to hold O-ring in place.
- While tightening the bolt by hand, check that flange is installed to the port correctly. Do not pinch the O-ring.
- Tighten the bolts up and down, left and right alternately, in order to ensure even tightening to the specified torque.
- Do not use air wrenches. Using an impact wrench often causes tightening of one bolt fully before tighten the others, resulting in damage to O-rings or uneven tightening of bolts.

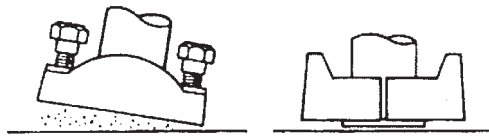

WDAA-01-02-005

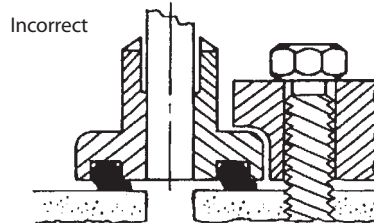

WDAA-01-02-006



W105-01-01-008

Nut and Bolt Locking

- Lock Plate

IMPORTANT: Do not reuse the lock plates. Do not try to bend the same point twice.

- Split Pin

IMPORTANT: Do not turn in the loosening direction in order to align the grooves and holes on the nut. Always turn in the tightening direction. Do not reuse the split pins.

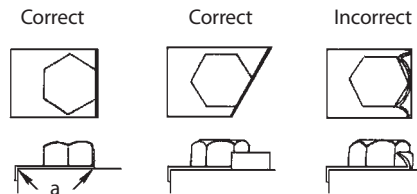
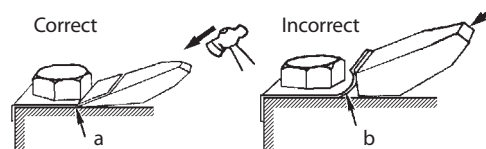

WDAA-01-02-007

a- Bend along edge sharply b- Do not bend it round

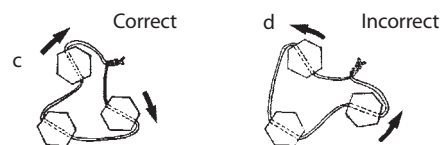
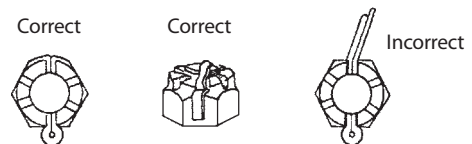

WDAA-01-02-008

c- Tighten d- Loosen

SECTION 1 GENERAL

Group 2 Tightening

Piping Joint

IMPORTANT:

- The torque given in table below are for general use only, however, a different torque is given for a specific application. Use the specified torque.
- Apply lubricant, such as the Grease Spray to the bolts and nuts in order to reduce friction coefficient of them.
- Torque tolerance is $\pm 10\%$.
- Slightly apply lubricant onto the threads first by using the Grease Spray.

SECTION 1 GENERAL

Group 2 Tightening

Union Joint

Metal sealing surfaces (4) and (5) of adapter (1) and hose (2) fit together to seal pressure oil. Union joints are used to join small-diameter lines.

IMPORTANT:

- **Do not over-tighten union nut (3). Excessive force will be applied to metal sealing surfaces (4) and (5), possibly cracking the adapter. Tighten union nut (3) to the specifications.**
- **Scratches or other damage to sealing surfaces (4) or (5) will cause oil leakage at the joint. Take care not to damage them when connecting / disconnecting.**

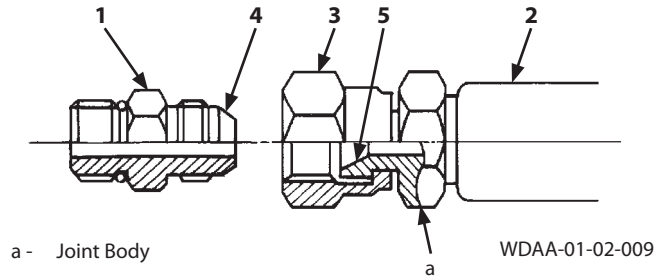

2013/09

Description	Wrench Size mm	Tightening Torque	
		N·m	(lbf·ft)
30 ° male	Union Nut		
	17	25	(18.5)
	19	30	(22)
	22	40	(29.5)
	27	80	(59)
	32	140	(103)
	36	180	(133)
	41	210	(155)
37 ° female	50	350	(260)
	55	380	(280)
	60	380	(280)
	17	25	(18.5)
	19	30	(22)
	22	40	(29.5)
	27	80	(59)
	32	140	(103)
37 ° female	36	180	(133)
	41	210	(155)
	50	350	(260)
	50	350	(260)

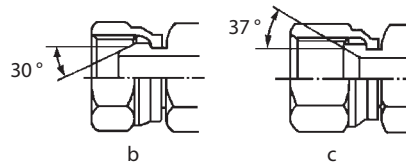

b - Male Union Joint

c - Female Union Joint

WDAA-01-02-010

 **NOTE:** Tightening torque of 37 ° male coupling without union is similar to tightening torque of 37° female.

SECTION 1 GENERAL

Group 2 Tightening

Pipe Joint

Pipe connection (metal joint)
(Union Nut Wrench Size: 17, 19, 22, 27)

Metal (3) of adapter (1) and pipe (2) seals pressure oil.

- Precautions for use
Do not damage sealing surfaces (4) and (5) when disassembling and assembling.

Tightening Torque
Use the specified tightening torque in the table below.

2013/09

Wrench Size (mm)		17	19	22	27
Tightening Torque	N·m	25	30	40	80
	(lbf·ft)	(18.5)	(22)	(29.5)	(59)

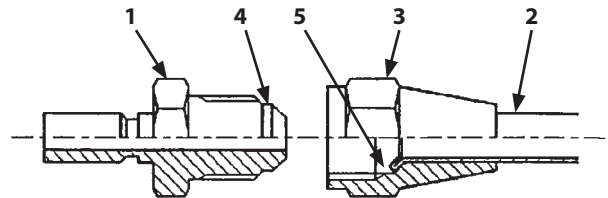

M1M7-07-005

O-ring Seal Joint

O-ring (6) is installed against the end surface of adapter (7) and seals pressure oil.

IMPORTANT:

- **Replace O-ring (6) with a new one when reinstalling.**
- **Before tightening union nut (9), confirm that O-ring (6) is seated correctly in O-ring groove (8). Tightening union nut (9) with O-ring (6) displaced will damage O-ring (6), resulting in oil leakage.**
- **Do not damage O-ring groove (8) of adapter (7) or sealing surface (10) on the hose side. Damage to O-ring (6) may cause oil leakage.**
- **If union nut (9) is found to be loose, causing oil leakage, do not tighten it to stop the leak. Instead, replace O-ring (6) with a new one, then tighten union nut (9) after confirming that O-ring (6) is securely seated in O-ring groove (8).**

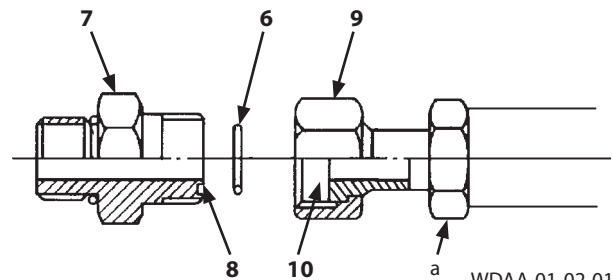

WDAA-01-02-011

a - Joint Body

2013/09

Wrench Size mm	Tightening Torque	
	N·m	(lbf·ft)
19	30	(22)
22	70	(52)
27	95	(70)
32	140	(103)
36	180	(133)
41	210	(155)
50	350	(260)

Thanks for your reading.

Please click here to download complete manual instantly.

And can also choose other manuals.

Feel free --->write to me with any questions.

Our service email:

manuals007@hotmail.com