

PART NO. WLBF50-EN-00

**HITACHI**

Reliable solutions

# Workshop Manual

# ZX190W-6 Wheeled Excavator

ZX190W-6 WHEELED EXCAVATOR WORKSHOP MANUAL

 **Hitachi Construction Machinery Co., Ltd.**

URL:<http://www.hitachi-c-m.com>

PRINTED IN JAPAN (K) 2017, 06

WLBF50-EN-00

Service Manual consists of the following separate Part No.  
Technical Manual (Operational Principle) : Vol. No.TOLBF50-EN  
Technical Manual (Troubleshooting) : Vol. No.TTLBF50-EN  
Workshop Manual : Vol. No.WLBF50-EN  
Engine Manual : Vol. No.ETDC150-EN, EWDC150-EN



---

---

## SECTION 1

# GENERAL

### CONTENTS

#### **Group 1 Precautions for Disassembling and Assembling**

Precautions for Disassembling  
and Assembling .....W1-1-1-1

#### **Group 2 Tightening**

Tightening Bolts and Nuts .....W1-2-1-1  
Piping Joint .....W1-2-1-4

#### **Group 3 Painting**

Painting .....W1-3-1-1

#### **Group 4 Bleeding Air**

Bleeding Air from Hydraulic System .....W1-4-1-1  
Bleeding Air from Fuel System .....W1-4-1-2  
Air Bleeding from the Diesel Exhaust  
Fluid Defrosting Piping .....W1-4-1-4  
Bleeding Air from Transmission .....W1-4-1-5  
Bleeding Air from Brake (Axle) .....W1-4-1-8

#### **Group 5 Preparation**

Preparation before Inspection  
and Maintenance.....W1-5-1-1  
Hydraulic Circuit Pressure Release Procedure .....W1-5-1-3  
Pressure Release from Hydraulic Oil Tank .....W1-5-1-4  
Pressure Release from Expansion Tank .....W1-5-1-5  
Pressure Release from Brake Circuit.....W1-5-1-6

---

(Blank)

---

---

## SECTION 2

# MAINTENANCE STANDARD

### CONTENTS

#### Group 1 Upperstructure

Pump Device .....	W2-1-1-1
Swing Motor .....	W2-1-2-1

#### Group 3 Front Attachment

Pin and Bushing.....	W2-3-1-1
Side Cutter (2015428, 2015429) .....	W2-3-1-3
Point (Z963228) .....	W2-3-1-4
Standard Dimensions for Arm and Bucket Connection .....	W2-3-1-5
Standard Dimensions for Arm and Boom Connection .....	W2-3-1-6
Cylinder .....	W2-3-2-1

---

(Blank)

---

---

## SECTION 3

# UPPERSTRUCTURE

### CONTENTS

#### Group 1 Cab

Removal and Installation of Cab .....	W3-1-1-1
Dimensions of Cab Glass.....	W3-1-2-1

#### Group 2 Counterweight

Removal and Installation of Counterweight.....	W3-2-1-1
--	----------

#### Group 3 Main Frame

Removal and Installation of Main Frame.....	W3-3-1-1
---	----------

#### Group 4 Engine

Removal and Installation of Engine .....	W3-4-1-1
--	----------

#### Group 8 Pump Device

Removal and Installation of Pump Device.....	W3-8-1-1
Removal and Installation of Coupling.....	W3-8-2-1
Removal and Installation of Pilot Pump .....	W3-8-3-1
Disassembly of Pump Device .....	W3-8-4-1
Assembly of Pump Device.....	W3-8-4-8
Disassembly of Regulator .....	W3-8-5-1
Assembly of Regulator.....	W3-8-5-3
Disassembly of Solenoid Valve Unit.....	W3-8-6-1
Assembly of Solenoid Valve Unit.....	W3-8-6-3
Structure of Pilot Pump .....	W3-8-7-1
Structure of Steering Pump .....	W3-8-8-1

#### Group 9 Control Valve

Removal and Installation of Control Valve.....	W3-9-1-1
Disassembly of Housing .....	W3-9-2-1
Assembly of Housing.....	W3-9-2-3
Disassembly of Control Valve (A Side) .....	W3-9-3-1
Assembly of Control Valve (A Side).....	W3-9-3-9
Disassembly of Control Valve (B Side) .....	W3-9-4-1
Assembly of Control Valve (B Side).....	W3-9-4-12
Disassembly of Control Valve (C Side) .....	W3-9-5-1
Assembly of Control Valve (Housing C Side).....	W3-9-5-6

#### Group 10 Swing Device

Removal and Installation of Swing Device .....	W3-10-1-1
Disassembly of Swing Reduction Gear .....	W3-10-2-1
Assembly of Swing Reduction Gear.....	W3-10-2-6
Disassembly of Swing Motor .....	W3-10-3-1
Assembly of Swing Motor.....	W3-10-3-4

#### Group 11 Pilot Valve

Removal and Installation of Pilot Valve (Left).....	W3-11-1-1
--	-----------

Removal and Installation of Pilot Valve (Right).....	W3-11-2-1
Removal and Installation of Travel Pilot Valve .....	W3-11-3-1
Disassembly of Pilot Valves (Right and Left) .....	W3-11-4-1
Assembly of Pilot Valves (Right and Left) .....	W3-11-4-4
Disassembly of Travel Pilot Valve.....	W3-11-5-1
Assembly of Travel Pilot Valves .....	W3-11-5-4

#### Group 12 Solenoid Valve

Removal and Installation of Pilot Shut-Off Solenoid Valve .....	W3-12-1-1
Removal and Installation of 4-Spool Solenoid Valve Unit .....	W3-12-2-1
Removal and Installation of Axle-lock/Brake Solenoid Valve Unit.....	W3-12-3-1
Removal and Installation of Pump 1/Pump 2 Flow Control Solenoid Valve Unit.....	W3-12-4-1
Removal and Installation of 7-Spool Solenoid Valve Unit .....	W3-12-5-1
Disassembly of Pilot Shut-Off Solenoid Valve ..	W3-12-6-1
Assembly of Pilot Shut-Off Solenoid Valve .....	W3-12-6-3
Structure of 4-Spool Solenoid Valve Unit.....	W3-12-7-1
Structure of Axle Lock/Brake S olenoid Valve Unit.....	W3-12-8-1
Structure of Pump1/Pump 2 Flow Rate Control Solenoid Valve Unit.....	W3-12-9-1
Structure of 7-Spool Solenoid Valve Unit.....	W3-12-10-1

#### Group 13 Signal Control Valve

Removal and Installation of Signal Control Valve .....	W3-13-1-1
Structure of Signal Control Valve .....	W3-13-2-1

#### Group 14 Aftertreatment Device

Removal and Installation of Aftertreatment Device.....	W3-14-1-1
---	-----------

#### Group 15 DEF Tank

Removal and Installation of DEF Tank.....	W3-15-1-1
---	-----------

#### Group 16 Coolant Control Valve

Removal and Installation of Coolant Control Valve .....	W3-16-1-1
--	-----------

#### Group 17 DEF Supply Module

Removal and Installation of DEF Supply Module .....	W3-17-1-1
--	-----------

---

---

## **Group 21 Shockless Valve**

- Removal and Installation of Swing Shockless Valve ..... W3-21-1-1
- Removal and Installation of Travel Shockless Valve ..... W3-21-2-1
- Structure of Swing Shockless Valve..... W3-21-3-1
- Structure of Travel Shockless Valve ..... W3-21-4-1

## **Group 22 Electric Lever**

- Removal and Installation of Electric Lever for Backup/Positioning ..... W3-22-1-1
- Removal and Installation of Electric Lever for Blade/Outrigger ..... W3-22-2-1
- Disassembly of Electric Lever ..... W3-22-3-1
- Assembly of Electric Lever..... W3-22-3-3

## **Group 23 Steering Valve**

- Removal and Installation of Steering Valve ..... W3-23-1-1
- Disassembly of Steering Valve ..... W3-23-2-1
- Assembly of Steering Valve ..... W3-23-2-4

## **Group 24 Brake Valve**

- Removal and Installation of Brake Valve..... W3-24-1-1
- Disassembly of Brake Valve ..... W3-24-2-1
- Assembly of Brake Valve ..... W3-24-2-5

## **CHAPTER 25 ACCUMULATOR CHARGE VALVE**

- Removal and Installation of Accumulator Charge Valve..... W3-25-1-1
- Structure of Accumulator Charging Valve ..... W3-25-2-1

## **Group 26 Accumulator Manifold**

- Removal and Installation of Accumulator Manifold..... W3-26-1-1
- Structure of Accumulator Manifold..... W3-26-2-1



---

---

## SECTION 4

# UNDERCARRIAGE

### CONTENTS

#### Group 1 Swing Bearing

Removal and Installation of Swing Bearing .....	W4-1-1-1
Disassembly of Swing Bearing .....	W4-1-2-1
Assembly of Swing Bearing.....	W4-1-2-4

#### Group 2 Travel Motor

Removal and Installation of Travel Motor .....	W4-2-1-1
Disassembly of Travel Motor .....	W4-2-2-1
Assembly of Travel Motor.....	W4-2-2-8
Disassembly of Brake Valve .....	W4-2-3-1
Assembly of Brake Valve.....	W4-2-3-3
Precautions for Using Floating Seal.....	W4-2-4-1

#### Group 3 Center Joint

Removal and Installation of Center Joint .....	W4-3-1-1
Disassembly of Center Joint .....	W4-3-2-1
Assembly of Center Joint .....	W4-3-2-3

#### Group 4 Transmission

Removal and Installation of Transmission .....	W4-4-1-1
Disassembly of Transmission .....	W4-4-2-1
Assembly of Transmission.....	W4-4-2-9

#### Group 5 Axle

Removal and Installation of Front Axle.....	W4-5-1-1
Removal and Installation of Rear Axle, Transmission .....	W4-5-2-1
Disassembly of Front Axle .....	W4-5-3-1
Assembly of Front Axle.....	W4-5-3-6
Disassembly of Rear Axle .....	W4-5-4-1
Assembly of Rear Axle.....	W4-5-4-5
Disassembly of Differential.....	W4-5-5-1
Assembly of Differential .....	W4-5-5-3
Disassembly of Steering Cylinder .....	W4-5-6-1
Assembly of Steering Cylinder .....	W4-5-6-3
Removal and Installation of Tie Rod .....	W4-5-7-1
Adjustment of Steering .....	W4-5-8-1

#### Group 6 Axle Lock Cylinder

Removal and Installation of Axle Lock Cylinder.....	W4-6-1-1
Disassembly of Axle Lock Cylinder .....	W4-6-2-1
Assembly of Axle Lock Cylinder.....	W4-6-2-3

#### Group 7 Operate Check Valve

Removal and Installation of Operate Check Valve (For Axel Lock Cylinder).....	W4-7-1-1
--	----------

Removal and Installation of Operate Check Valve (For Blade Cylinder).....	W4-7-2-1
Removal and Installation of Operate Check Valve for Outrigger Cylinder.....	W4-7-3-1
Structure of Operate Check Valve (For Axel Lock Cylinder).....	W4-7-4-1
Structure of Operate Check Valve (For Blade/Outrigger Cylinder) .....	W4-7-5-1

#### Group 8 Solenoid Valve

Removal and Installation of 2-Spool Solenoid Valve Unit for Blade/Outrigger Cylinder .....	W4-8-1-1
Removal and Installation of Transmission Control Solenoid Valve .....	W4-8-2-1
Structure of 2-Spool Solenoid Valve Unit (For Blade/ Outrigger Cylinder) .....	W4-8-3-1

#### Group 9 Propeller Shaft

Removal and Installation of Propeller Shaft.....	W4-9-1-1
--	----------

#### Group 10 Cylinder

Removal and Installation of Blade Cylinder .....	W4-10-1-1
Removal and Installation of Outrigger Cylinder .....	W4-10-2-1
Disassembly of Blade/ Outrigger Cylinders.....	W4-10-3-1
Assembly of Blade/ Outrigger Cylinders .....	W4-10-3-3

#### Group 11 Tire

Removal and Installation of Front Tire .....	W4-11-1-1
Removal and Installation of Rear Tire .....	W4-11-2-1
Disassembly of Tire Assembly .....	W4-11-3-1
Assembly of Tire Assembly.....	W4-11-3-2

---

(Blank)

---

---

## SECTION 5

# FRONT ATTACHMENT

### CONTENTS

#### Group 1 Front Attachment

- Removal and Installation of Front Attachment  
(Monoboom).....W5-1-1-1
- Removal and Installation of Front Attachment  
(2-piece boom).....W5-1-2-1

#### Group 2 Cylinder

- Removal and Installation of Boom Cylinder.....W5-2-1-1
- Removal and Installation of Arm Cylinder.....W5-2-2-1
- Removal and Installation of Bucket Cylinder.....W5-2-3-1
- Removal and Installation of  
Positioning Cylinder.....W5-2-4-1
- Disassembly of Boom, Arm, Bucket,  
and Positioning Cylinders.....W5-2-5-1
- Assembly of Boom, Arm, Bucket,  
and Positioning Cylinders.....W5-2-5-9

#### Group 3 Hose Rupture Valve

- Removal and Installation of Hose Rupture  
Valve for Boom Cylinder.....W5-3-1-1
- Removal and Installation of Hose Rupture  
Valve for Arm Cylinder.....W5-3-2-1
- Removal and Installation of Hose Rupture  
Valve for Positioning Cylinder.....W5-3-3-1
- Structure of Hose Rupture Valve for  
Boom Cylinder.....W5-3-4-1
- Structure of Hose Rupture Valve for  
Arm Cylinder.....W5-3-4-5
- Structure of Hose Rupture Valve for  
Positioning Cylinder.....W5-3-4-7

---

(Blank)

---

# INTRODUCTION

---

## To The Reader

This manual is written for an experienced technician to provide technical information needed to maintain and repair this machine.

The machine specification and description according to destination may be explained on this manual.

- Be sure to thoroughly read this manual for correct product information and service procedures.

- If you have any questions or comments, or if you found any errors regarding the contents of this manual, please contact using "Service Manual Revision Request Form" at the end of this manual. (Note: Do not tear off the form. Copy it for usage.):
  - Technical Information Center Hitachi Construction Machinery Co., Ltd.
  - TEL: 81-29-832-7084
  - FAX: 81-29-831-1162
  - E-mail: HCM-TIC-GES@hitachi-kenki.com

---

## Additional References

Please refer to the other materials (operator's manual, parts catalog, engine technical material and Hitachi training material etc.) in addition to this manual.

---

## Manual Composition

This manual consists of the Technical Manual, the Workshop Manual and the Engine Manual.

- Information included in the Technical Manual: Technical information needed for redelivery and delivery, operation and activation of all devices and systems, operational performance tests, and troubleshooting procedures.

- Information included in the Workshop Manual: Technical information needed for maintenance and repair of the machine, tools and devices needed for maintenance and repair, maintenance standards, and removal / installation and assemble / disassemble procedures.

- Information included in the Engine Manual: Technical information needed for redelivery and delivery and maintenance and repair of the machine, operation and activation of all devices and systems, troubleshooting and assemble / disassemble procedures.

---

## Page Number

Each page has a number, located on the center lower part of the page, and each number contains the following information:

Example:

- Technical Manual: T 1-3-5

T	Technical Manual
1	Section Number
3	Group Number
5	Consecutive Page Number for Each Group

- Workshop Manual: W 1-3-2-5

W	Workshop Manual
1	Section Number
3	Group Number
2	Sub Group Number
5	Consecutive Page Number for Each Group

---

## Trademark

AdBlue® is a registered trademark of the Verband der Automobilindustrie e.V. (VDA).

# INTRODUCTION

---

## Safety Alert Symbol and Headline Notations

In this manual, the following safety alert symbol and signal words are used to alert the reader to the potential for personal injury of machine damage.

 This is the safety alert symbol. When you see this symbol, be alert to the potential for personal injury. Never fail to follow the safety instructions prescribed along with the safety alert symbol. The safety alert symbol is also used to draw attention to component/part weights. To avoid injury and damage, be sure to use appropriate lifting techniques and equipment when lifting heavy parts.

 **CAUTION:**

Indicates potentially hazardous situation which could, if not avoided, result in personal injury or death.

**IMPORTANT:**

Indicates a situation which, if not conformed to the instructions, could result in damage to the machine.

 **NOTE:**

Indicates supplementary technical information or know-how.

## Units Used

SI Units (International System of Units) are used in this manual.

A table for conversion from SI units to other system units is shown below for reference purposes.

Quantity	To Convert From	Into	Multiply By
Length	mm	in	0.03937
	mm	ft	0.003281
Volume	L	US gal	0.2642
	L	US qt	1.057
	m <sup>3</sup>	yd <sup>3</sup>	1.308
Weight	kg	lb	2.205
Force	N	kgf	0.10197
	N	lbf	0.2248
Torque	N·m	kgf·m	0.10197
Pressure	MPa	kgf/cm <sup>2</sup>	10.197
	MPa	psi	145.0
Power	kW	PS	1.360
	kW	HP	1.341
Temperature	°C	°F	°C×1.8+32
Velocity	km/h	mph	0.6214
	min <sup>-1</sup>	rpm	1.0
Flow rate	L/min	US gpm	0.2642
	mL/rev	cc/rev	1.0

## SYMBOL AND ABBREVIATION

Symbol / Abbreviation	Name	Explanation
TO	Technical manual (Operational principle)	Technical manual (Operational Principle).
TT	Technical manual (Troubleshooting)	Technical manual (Troubleshooting).
T/M	Technical manual	Technical manual.
W, W/M	Workshop manual	Workshop manual (Removal and Installation, Disassembly and Assembly).
MC	Main Controller	Main controller. MC controls the engine, pump, and valve according to the machine operating condition.
ECM	Engine Control Module	Engine controller. ECM controls fuel injection amount according to the machine operating condition.
VGS	Variable Geometry System controller	Variable turbo controller. VGS is an exhaust turbo charged system to supercharge the exhaust energy while running the engine at slow idle speed. VGS optimizes the turbine rotation, improves the performance at slow-speed torque and the acceleration, reduces fuel consumption, and reduces particulate matter (PM) by adjusting the nozzle opening of turbine housing.
GSM	Global System for Mobile communications controller	Communication controller. GSM is a type of wireless communication system, is used in more than on 100 countries around Europe and Asia, and becomes the factual global standards of the mobile telephone.
GPS	Global Positioning System	Global positioning system.
CAN	Controller Area Network	CAN communication. CAN is a serial communications protocol internationally-standardized by ISO (International Organization for Standardization).
A/C	Air Conditioner	Air conditioner.
OP, OPT	Option	Optional component.
MPDr.	Maintenance Pro Dr.	MPDr. is software that troubleshooting, monitoring, and adjustment.
A/I	Auto-Idle	Auto-idle.
WU	Warming-Up	Warming-up.
Li	Low (Slow) Idle	Slow idle engine speed.
ATT	Attachment	Attachment. Attachment is optional parts such as breaker, crusher, and pulverizer in this manual.
HI, Hi	High	Travel fast position.
LO, Lo	Low	Travel slow position.

## SYMBOL AND ABBREVIATION

Symbol / Abbreviation	Name	Explanation
DPF	Diesel Particulate Filter	DPF is a filter which removes particulate matter (PM) including the toxic substance of exhaust gas of the diesel engine. Exhaust particulate removal equipment.
DPD	Diesel Particulate Diffuser	DPD is an exhaust emission control system, a type of DPF, which cleans up particulate matter (PM) of diesel engine exhaust gas. DPD is a ceramic filter which traps and filters PM of exhaust gas. DPD burns up accumulated PM when PM increases and regenerates the filter.
DOC	Diesel Oxidation Catalyst	Oxidation catalyst for the diesel engine. Diesel oxidation catalyst oxidizes unburnt fuel and raises exhaust temperature.
CSF	Catalyzed Soot Filter	Filter. The filter traps, burns, and remove particulate matter (PM) by using high-temperature-exhaust gas with diesel oxidation catalyst. Catalyst is applied onto the filter. This advances PM burning.
PM	Particulate Matter	Particulate matter.
EGR	Exhaust Gas Recirculation	The EGR control re-circulates a part of exhaust gas in the intake manifold and combines it with intake-air. Therefore, combustion temperature is lowered and generation of oxide of nitrogen (NOx) is controlled.
HRV	Hose Rupture Valve	Hose rupture valve.
LLC	Long Life Coolant	Long life coolant.
SCR	Selective Catalytic Reduction	The urea SCR system injects diesel exhaust fluid to nitrogen oxide (NOx) exhausted from the engine and purifies NOx.
DCU	Dosing Control Unit	Urea SCR system controller. DCU controls the diesel exhaust fluid injection amount according to the machine operating condition.
S/M	Supply Module	Diesel exhaust fluid supply module. The diesel exhaust fluid supply module pumps diesel exhaust fluid to the dosing module (D/M). Then, it returns diesel exhaust fluid in the diesel exhaust fluid circuit when the key switch is turned OFF.
D/M	Dosing Module	Dosing module. The dosing module (D/M) injects diesel exhaust fluid into the exhaust piping according to the signal from DCU.
NOx	Nitrogen Oxide	Nitrogen oxide.
DEF	Diesel Exhaust Fluid	Diesel exhaust fluid. The diesel exhaust fluid concentration is 32.5 %, which is specified in ISO22241.



## SAFETY

---

### Recognize Safety Information

- These are the **SAFETY ALERT SYMBOLS**.
  - When you see these symbols on your machine or in this manual, be alert to the potential for personal injury.
  - Follow recommended precautions and safe operating practices.



SA-2644

### Understand Signal Words

- On machine safety signs, signal words designating the degree or level of hazard - **DANGER**, **WARNING**, or **CAUTION** - are used with the safety alert symbol.
  - **DANGER** indicates an imminently hazardous situation which, if not avoided, will result in death or serious injury.
  - **WARNING** indicates a potentially hazardous situation which, if not avoided, could result in death or serious injury.
  - **CAUTION** indicates a potentially hazardous situation which, if not avoided, may result in minor or moderate injury.
  - **DANGER or WARNING safety signs** are located near specific hazards. General precautions are listed on **CAUTION safety signs**.
  - Some safety signs are occasionally used on this machine that do not use any of the designated signal words mentioned above after the safety alert symbol.
- **CAUTION** also calls attention to safety message in this manual.
- To avoid confusing machine protection with personal safety messages, a signal word **IMPORTANT** indicates a situation which, if not avoided, could result in damage to the machine.
-  **NOTE**: Indicates an additional explanation for a piece of information.



**IMPORTANT**



SA-1223

## SAFETY

---

### Follow Safety Instructions

- Carefully read and follow all safety signs on the machine and all safety messages in the operator's manual.
- Safety signs should be installed, maintained and replaced when necessary.
  - If a safety sign or operator's manual is damaged or missing, order a replacement from your authorized dealer in the same way you order other replacement parts (be sure to state machine model and serial number when ordering).
- Learn how to operate the machine and its controls correctly and safely.
- Allow only trained, qualified, authorized personnel to operate the machine.
- Keep your machine in proper working condition.
  - Unauthorized modifications of the machine may impair its function and/or safety and affect machine life.
  - Do not modify any machine parts without authorization. Failure to do so may deteriorate the safety, function, and/or service life of the part. In addition, personal accident, machine trouble, and/or damage to material caused by unauthorized modifications will void Hitachi Warranty Policy.
  - Never attempt to modify or disassemble the inlet/exhaust parts and the aftertreatment device. Avoid shocks to the element of the aftertreatment device, such as striking or dropping objects onto the element. Failure to do so may affect the exhaust gas purifying device, possibly damaging it or lowering its performance.
  - Do not use attachments and/or optional parts or equipment not authorized by Hitachi. Failure to do so may deteriorate the safety, function, and/or service life of the machine. In addition, personal accident, machine trouble, and/or damage to material caused by using unauthorized attachments and/or optional parts or equipment will void Hitachi Warranty Policy.
- The safety messages in this SAFETY chapter are intended to illustrate basic safety procedures of machines. However it is impossible for these safety messages to cover every hazardous situation you may encounter. If you have any questions, you should first consult your supervisor and/or your authorized dealer before operating or performing maintenance work on the machine.

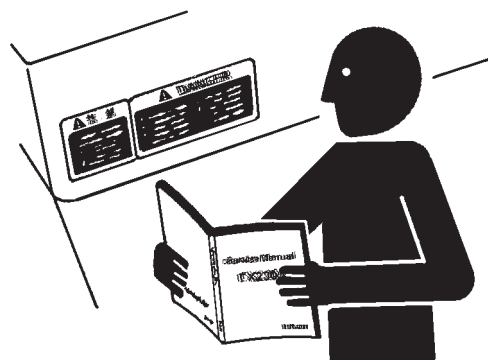

SA-003

## SAFETY

---

### Prepare for Emergencies

- Be prepared for a fire or an accident.
  - Keep a first aid kit and fire extinguisher on hand.
  - Thoroughly read and understand the label attached on the fire extinguisher to use it properly.
  - To ensure that a fire extinguisher can be always used when necessary, check and service the fire extinguisher at the recommended intervals as specified in the fire extinguisher manual.
  - Establish emergency procedure guidelines to cope with fires and accidents.
  - Keep emergency numbers for doctors, ambulance service, hospital, and fire department posted near your telephone.



SA-437

---

### Wear Protective Clothing

- Wear close fitting clothing and safety equipment appropriate to the job.

You may need:

- A hard hat
- Safety shoes
- Safety glasses, goggles, or face shield
- Heavy gloves
- Hearing protection
- Reflective clothing
- Wet weather gear
- Respirator or filter mask

Be sure to wear the correct equipment and clothing for the job. Do not take any chances.

- Avoid wearing loose clothing, jewelry, or other items that can catch on control levers or other parts of the machine.
- Operating equipment safely requires the full attention of the operator. Do not wear radio or music headphones while operating the machine.

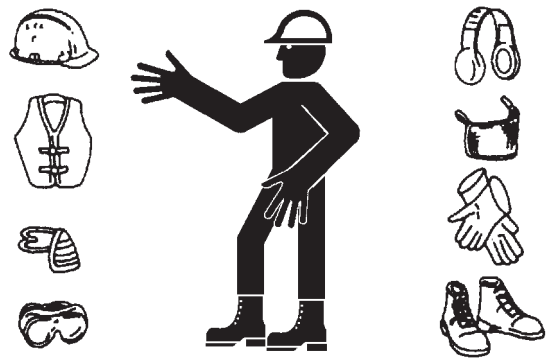

SA-438

## SAFETY

---

### Protect Against Noise

- Prolonged exposure to loud noise can cause impairment or loss of hearing.
  - Wear a suitable hearing protective device such as earmuffs or earplugs to protect against objectionable or uncomfortably loud noises.



SA-434

---

### Inspect Machine

- Inspect your machine carefully each day or shift by walking around it before you start it to avoid personal injury.
  - In the walk-around inspection be sure to cover all points described in the "Inspect Machine Daily Before Starting" section in the operator's manual.



SA-435

## SAFETY

---

### General Precautions for the Cab

- Before entering the cab, thoroughly remove all dirt and/or oil such as mud, grease, soil or stones from the soles of your work boots. If any controls such as a pedal is operated while with dirt and/or oil on the soles of the operator's work boots, the operator's foot may slip off the pedal, possibly resulting in a personal accident.
- Do not mess up around the operator's seat with parts, tools, soil, stones, obstacles that may fold up or turn over, cans or lunch box. The levers or pedals become inoperable if obstacle jams in operation stroke of the accelerator pedal, brake pedal, pilot control shut-off lever or control levers, which may result in serious injury or death.
- Avoid storing transparent bottles in the cab. Do not attach any transparent type window decorations on the windowpanes as they may focus sunlight, possibly starting a fire.
- Refrain from listening to the radio, or using music headphones or mobile telephones in the cab while operating the machine.
- Keep all flammable materials and/or explosives away from the machine.
- After using the ashtray, always cover it to extinguish the match and/or tobacco.
- Do not leave cigarette lighters in the cab. When the temperature in the cab increases, the lighter may explode.
- Correctly lay the floor mat specific to the machine. If another floor mat is used, it may be displaced and contact with the accelerator or brake pedals during operation, resulting in serious injury or death.

## SAFETY

---

### Use Handholds and Steps

- Falling is one of the major causes of personal injury.
  - When you get on and off the machine, always face the machine and maintain a three-point contact with the steps and handrails.
  - Do not use any controls as hand-holds.
  - Never jump on or off the machine. Never mount or dismount a moving machine.
  - Before getting on or off the machine, check the condition of the steps and handrails for sticking or slippery material like grease or mud. Thoroughly remove such material if stuck. In addition, repair the damage to the steps and/or handrails. Retighten loose bolts.
  - Never get on and off the machine with tools in your hands.

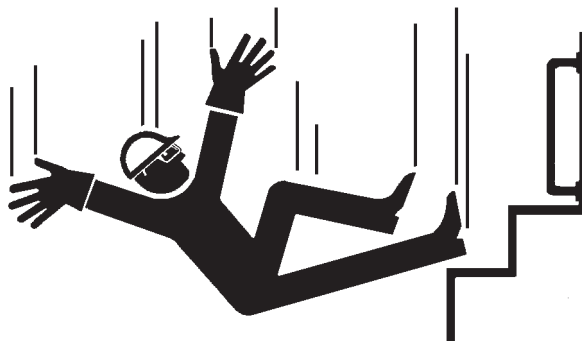

SA-439

---

### Adjust the Operator's Seat

- A seat which is poorly adjusted for the individual operator, or work to be undertaken, may quickly fatigue the operator leading to misoperation.
  - The seat should be adjusted whenever the operator of the machine changes.
  - The operator should be able to fully depress the pedals and to correctly operate the control levers with his back against the seat back.
  - If not, move the seat forward or backward, and check again.
  - Adjust mirror (s) position to obtain best visibility from the operator's seat. If any mirror is broken, immediately replace it with a new one.



SA-378

## SAFETY

---

### Ensure Safety Before Rising from or Leaving Operator's Seat

- Before rising from the operator's seat to open/close either side window or to adjust the seat position, be sure to first lower the front attachment to the ground and then move the pilot control shut-off lever to the LOCK position, and put the brake switch in the P (parking brake) position. Failure to do so may allow the machine to unexpectedly move when a body part unintentionally comes in contact with a control lever and/or pedal, possibly resulting in serious personal injury or death.
- Before leaving the machine, be sure to first lower the front attachment to the ground and then move the pilot control shut-off lever to the LOCK position, and put the brake switch in the P (parking brake) position. Turn the key switch OFF to stop the engine.
- Before leaving the machine, close all windows, doors, and access covers and lock them.

---

### Fasten Your Seat Belt

- If the machine should overturn, the operator may become injured and/or thrown from the cab. Additionally the operator may be crushed by the overturning machine, resulting in serious injury or death.
  - Prior to operating the machine, thoroughly examine webbing, buckle and attaching hardware. If any item is damaged or worn, replace the seat belt or component before operating the machine.
  - Be sure to remain seated with the seat belt securely fastened at all times when the machine is in operation to minimize the chance of injury from an accident.
  - We recommend that the seat belt is replaced every three years regardless of its apparent condition.



SA-237

## SAFETY

### Move and Operate Machine Safely

- Bystanders can be run over.
  - Take extra care not to run over bystanders. Confirm the location of bystanders before moving, swinging, or operating the machine.
  - Always keep the travel alarm and horn in working condition (if equipped). It warns people when the machine starts to move.
  - Use a signal person when moving, swinging, or operating the machine in congested areas. Coordinate hand signals before starting the machine.
  - Use appropriate illumination. Check that all lights are operable before operating the machine. If any faulty illumination is present, immediately repair it.
  - Ensure the cab door, windows, doors and covers are securely locked.
  - Check the mirrors and the monitor in the cab for problems.  
If there is, replace the problem part (s) or clean the mirror, camera and the monitor.  
Refer to "Rear View Monitor" section in the operator's manual for information on cleaning the camera lens and the monitor display.



SA-083

### Operate Only from Operator's Seat

- Inappropriate engine starting procedures may cause the machine to runaway, possibly resulting in serious injury or death.
  - Start the engine only when seated in the operator's seat.
  - Never start the engine while standing on the track or ground.
  - Do not start engine by shorting across starter terminals.
  - Before starting the engine, confirm that all control levers are in neutral.
  - Before starting the engine, confirm the safety around the machine and sound the horn to alert bystanders.

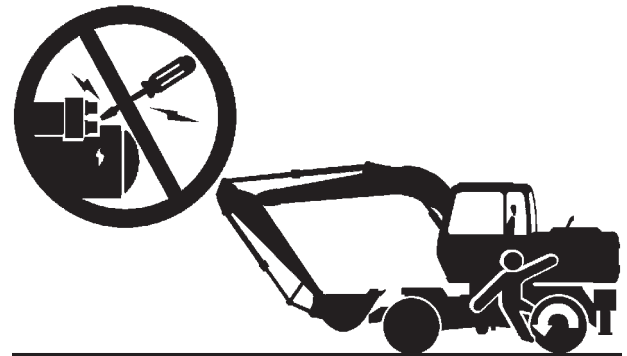

SA-084



## SAFETY

---

### Jump Starting

- Battery gas can explode, resulting in serious injury.
  - If the engine must be jump started, be sure to follow the instructions shown in the “OPERATING THE ENGINE” chapter in the operator’s manual.
  - The operator must be in the operator’s seat so that the machine will be under control when the engine starts. Jump starting is a two-person operation.
  - Never use a frozen battery.
  - Failure to follow correct jump starting procedures could result in a battery explosion or a runaway machine.

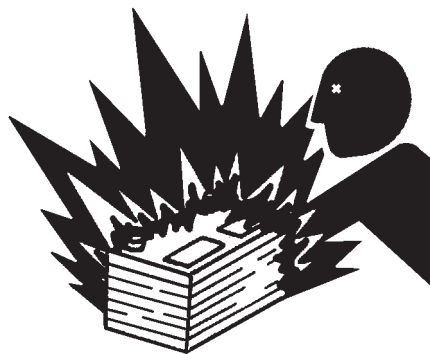

SA-032

---

### Keep Riders off Machine

- Riders on machine are subject to injury such as being struck by foreign objects and being thrown off the machine.
  - Only the operator should be on the machine. Keep riders off.
  - Riders also obstruct the operator’s view, resulting in the machine being operated in an unsafe manner.



SA-091

## SAFETY

---

### Precautions for Operations

- Investigate the work site before starting operations.
  - Be sure to wear close fitting clothing and safety equipment appropriate for the job, such as a hard hat, etc. when operating the machine.
  - Keep bystanders and obstacles clear of the area of machine operation. Keep persons other than the operator away from areas where there is danger, such as from flying objects. Always be aware of the surroundings while operating. When working in a small area surrounded by obstacles, take care not to hit the upperstructure against obstacles.
  - When loading onto trucks, bring the bucket over the truck beds from the rear side. Take care not to swing the bucket over the cab or over any person.

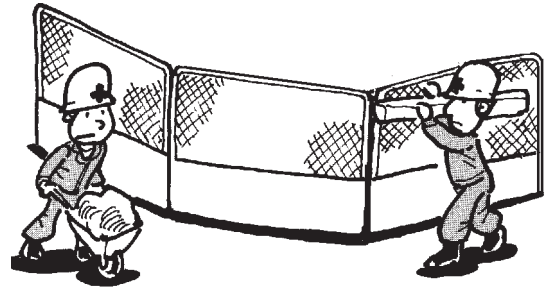
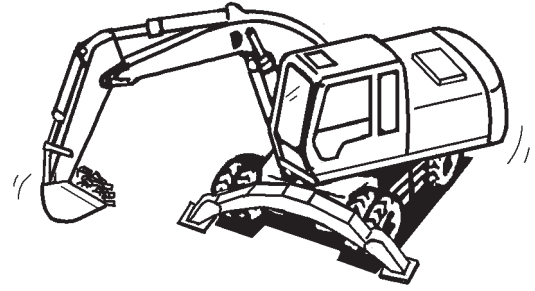

M202-05-014

## SAFETY

---

### Investigate Job Site Beforehand

- When working at the edge of an excavation or on a road shoulder, the machine could tip over, possibly resulting in serious injury or death.
  - Investigate the configuration and ground conditions of the job site beforehand to prevent the machine from falling and to prevent the ground, stockpiles or banks from collapsing.
  - Make a work plan. Use machines appropriate to the work and job site.
  - Reinforce ground, edges and road shoulders as necessary. Keep the machine well back from the edges of excavations and road shoulders.
  - When working on an incline or on a road shoulder, employ a signal person as required.
  - Confirm that your machine is equipped with a FOPS cab before working in areas where the possibility of falling stones or debris exist.
  - When the ground footing is weak, reinforce the ground before starting work.
  - When working on frozen ground, be extremely alert. As ambient temperatures rise, footing becomes loose and slippery.
  - Beware the possibility of fire when operating the machine near flammable materials such as dry grass.



SA-085

## SAFETY

---

- Make sure the worksite has sufficient strength to firmly support the machine.  
When working close to an excavation or at road shoulders, operate the machine with the tracks positioned perpendicular to the cliff face with travel motors at the rear, so that the machine can more easily evacuate if the cliff face collapses.
- If working on the bottom of a cliff or a high bank is required, be sure to investigate the area first and confirm that no danger of the cliff or bank collapsing exists. If any possibility of cliff or bank collapsing exists, do not work on the area.
- Soft ground may collapse when the machine is operated on it, possibly causing the machine to tip over. When working on soft ground is required, be sure to reinforce the ground first using steel plates strong and firm enough to easily support the machine.
- Note that there is always a possibility of machine tipping over when working on rough terrain or on slopes. Prevent machine tipping over from occurring. When operating on rough terrain or on slopes:
  - Reduce the engine speed.
  - Select slow travel speed mode.
  - Operate the machine slowly and be cautious with machine movements.

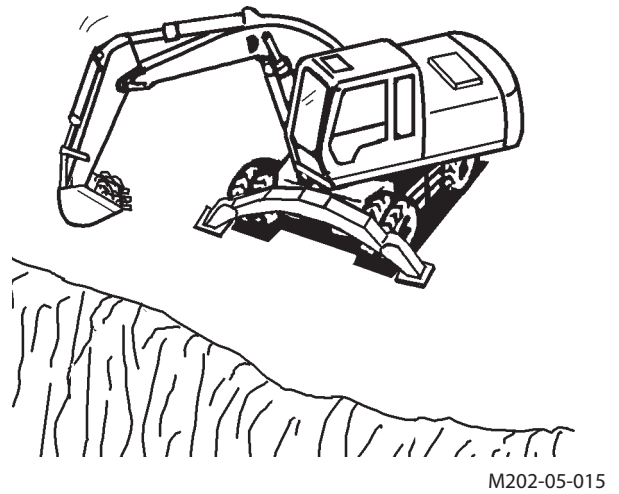

---

### Install OPG Guard

In case the machine is operated in areas where the possibilities of falling stones or debris exist, equip Hitachi OPG guard. Consult your authorized dealer for installing the OPG guard. In order not to impair operator protective structure: Replace damaged OPG guard. Never attempt to repair or modify the guard.

OPG: Operator Protective Guard

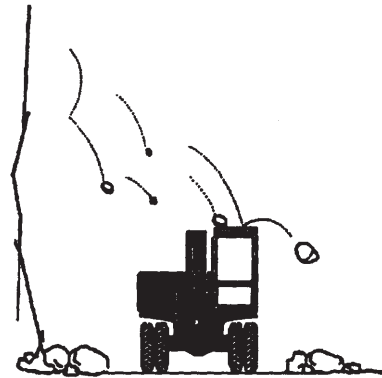

---

### Restriction of Attachment Installation

- Do not install an attachment which exceeds specified weight for the machine structure.

## SAFETY

---

### Provide Signals for Jobs Involving Multiple Machines

- For jobs involving multiple machines, provide signals commonly known by all personnel involved. Also, appoint a signal person to coordinate the job site. Make sure that all personnel obey the signal person's directions.



SA-481

### Confirm Direction of Machine to Be Driven

- Incorrect steering wheel/F-N-R switch operation may result in serious injury or death.
  - Before driving the machine, confirm the position of the undercarriage in relation to the operator's position. If the travel motors are located in front of the cab, the machine will move in reverse when travel F-N-R switch is operated facing forwards.



SA-092

## SAFETY

### Drive Machine Safely

- Before driving the machine, always confirm that the steering wheel/F-N-R switch direction corresponds to the direction you wish to drive.
  - Be sure to detour around any obstructions.
  - Avoid traveling over obstructions. Soil, fragments of rocks, and/or metal pieces may scatter around the machine. Do not allow personnel to stay around the machine while traveling.
- Driving on a slope may cause the machine to slip or overturn, possibly resulting in serious injury or death.
  - Never attempt to ascend or descend slopes that exceed the gradeability rating of the machine.
  - Be sure to fasten the seat belt.
  - When driving up or down a slope, keep the bucket facing the direction of travel, approximately 0.5 to 1.0 m (see A on the right) above the ground.
  - If the machine starts to skid or becomes unstable, immediately lower the bucket to the ground and stop.
  - Driving across the face of a slope or steering on a slope may cause the machine to skid or turnover. If the direction must be changed, move the machine to level ground, then, change the direction to ensure safe operation.
  - Avoid swinging the upperstructure on slopes. Never attempt to swing the upperstructure downhill. The machine may tip over. If swinging uphill is unavoidable, carefully operate the upperstructure and boom at slow speed.
  - If the engine stalls on a slope, immediately lower the bucket to the ground. Return the control levers to neutral. Then, restart the engine.
  - Be sure to thoroughly warm up the machine before ascending steep slopes. If hydraulic oil has not warmed up sufficiently, sufficient performance may not be obtained.

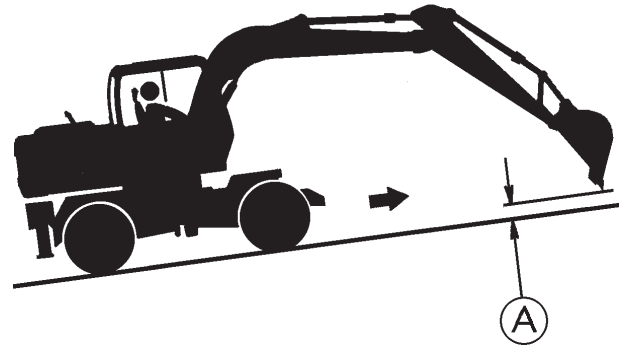

SA-090

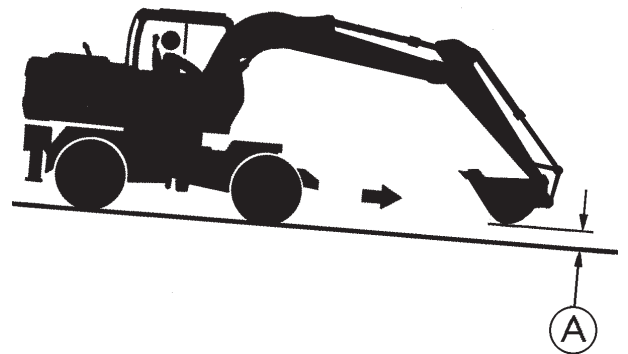

SA-288

## SAFETY

### Avoid Injury from Rollaway Accidents

- Death or serious injury may result if you attempt to mount or stop a moving machine.  
To avoid rollaways:
  1. Select level ground when possible to park machine.
  2. Do not park the machine on a gradient.
  3. Lower the bucket and/or other work tools to the ground.
  4. Pull the pilot control shut-off lever to LOCK position.
  5. Place F-N-R switch in the neutral, and put the brake switch in the P (parking brake) position.
  6. Turn the auto-idle switch off.
  7. Run the engine at slow idle speed without load for 5 minutes to cool down the engine.
  8. Stop the engine and remove the key from the key switch.
  9. Block both tires and lower the bucket to the ground. Thrust the bucket teeth into the ground if you must park on a gradient.
  10. Position the machine to prevent rolling.
  11. Park at a reasonable distance from other machines.

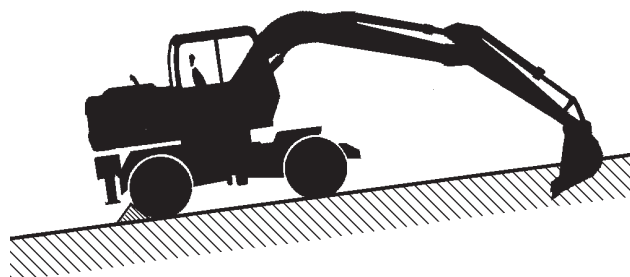
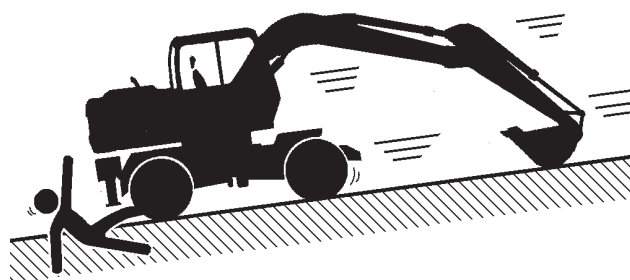

SA-278

## SAFETY

---

### Avoid Injury from Back-Over and Swing Accidents

- If any person is present near the machine when backing or swinging the upperstructure, the machine may hit or run over that person, resulting in serious injury or death.

To avoid back-over and swing accidents:

- Always look around BEFORE YOU BACK UP AND SWING THE MACHINE. BE SURE THAT ALL BYSTANDERS ARE CLEAR.
- Keep the travel alarm in working condition (if equipped). ALWAYS BE ALERT FOR BYSTANDERS MOVING INTO THE WORK AREA. USE THE HORN OR OTHER SIGNAL TO WARN BYSTANDERS BEFORE MOVING MACHINE.
- USE A SIGNAL PERSON WHEN BACKING UP IF YOUR VIEW IS OBSTRUCTED. ALWAYS KEEP THE SIGNAL PERSON IN VIEW.

Use hand signals, which conform to your local regulations, when work conditions require a signal person.

- No machine motions shall be made unless signals are clearly understood by both signal person and operator.
- Learn the meanings of all flags, signs, and markings used on the job and confirm who has the responsibility for signaling.
- Keep windows, mirrors, and lights clean and in good condition.
- Dust, heavy rain, fog, etc., can reduce visibility. As visibility decreases, reduce speed and use proper lighting.
- Read and understand all operating instructions in the operator's manual.



SA-383

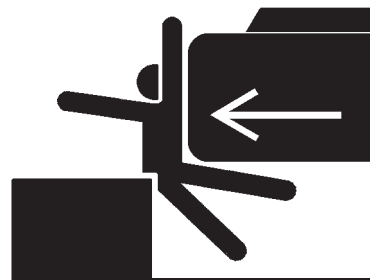

SA-384



## SAFETY

---

### Keep People Clear from Working Area

- People around the operating machine may be hit severely by the swinging front attachment or counterweight, be caught in other objects, and/or be struck by flying objects, resulting in serious injury or death.
- Set up barriers and/or put a "NO ADMISSION" sign at the machine operating site and areas exposed by flying objects to prevent anyone from entering the work area.
- Before operating the machine, set up barriers to the sides and rear area of the buckets swing radius to prevent anyone from entering the work area.

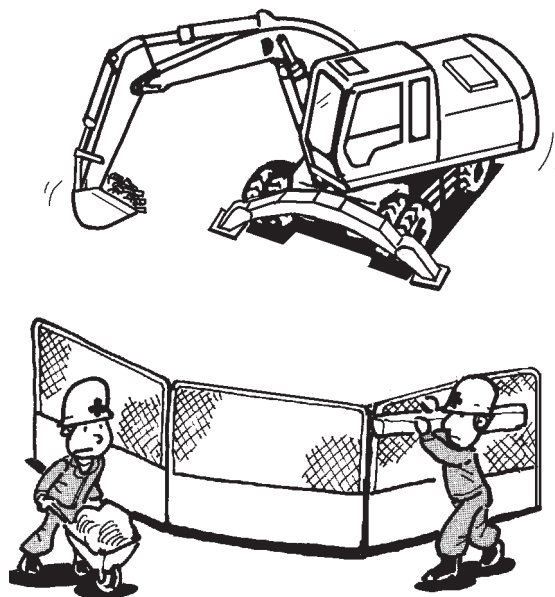

M202-05-014

---

### Never Position the Bucket Over Anyone

- Never lift, move, or swing the bucket above anyone or above the truck cab. Serious injury or machine damage may result due to bucket load spill or due to collision with the bucket.



SA-682

## SAFETY

### Avoid Undercutting

- Always confirm that ground conditions are strong enough to support the machine weight when operating near a cliff. Operate the machine with the chassis frame positioned perpendicular to the cliff face so that the machine can more easily evacuate if the cliff face collapses.
- If the footing starts to collapse and if retreat is not possible, do not panic. Often, the machine can be secured by lowering the front attachment, in such cases.



SA-683

### Avoid Tipping

**DO NOT ATTEMPT TO JUMP CLEAR OF TIPPING MACHINE  
--- SERIOUS OR FATAL CRUSHING INJURIES WILL RESULT  
MACHINE WILL TIP OVER FASTER THAN YOU CAN JUMP  
FREE**

#### **FASTEN YOUR SEAT BELT**

- The danger of tipping is always present when operating on a grade, possibly resulting in serious injury or death. To avoid tipping:
- Be extra careful before operating on a gradient.
  - Prepare machine operating area flat.
  - Keep the bucket low to the ground and close to the machine.
  - Reduce operating speeds to avoid tipping or slipping.
  - Avoid changing direction when traveling on grades.
  - NEVER attempt to travel across a grade steeper than 15 degrees if crossing the grade is unavoidable.
  - Reduce swing speed as necessary when swinging loads.
- Be careful when working on frozen ground.
  - Temperature increases will cause the ground to become soft and make ground travel unstable.

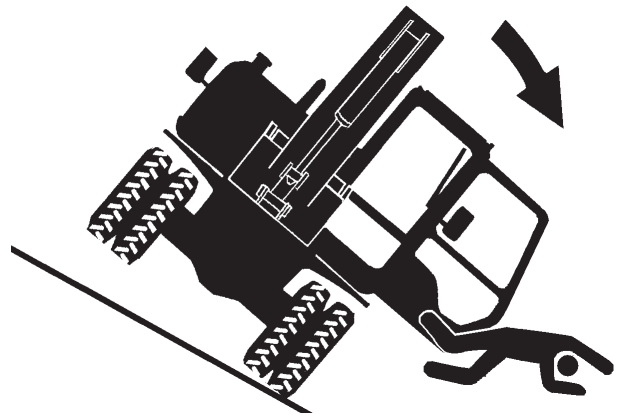

SA-088

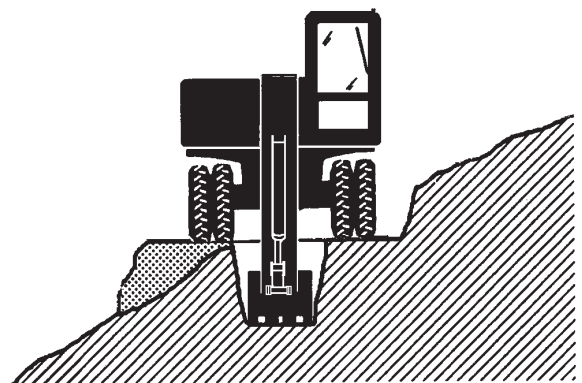

SA-684

## SAFETY

---

### Never Undercut a High Bank

- The edges could collapse or a land slide could occur causing serious injury or death.



SA-685

### Dig with Caution

- Accidental severing of underground cables or gas lines may cause an explosion and/or fire, possibly resulting in serious injury or death.
  - Before digging check the location of cables, gas lines, and water lines.
  - Keep the minimum distance required, by law, from cables, gas lines, and water lines.
  - If a fiber optic cable should be accidentally severed, do not look into the end. Doing so may result in serious eye injury.
  - Contact your local "diggers hot line" if available in your area, and/or the utility companies directly. Have them mark all underground utilities.

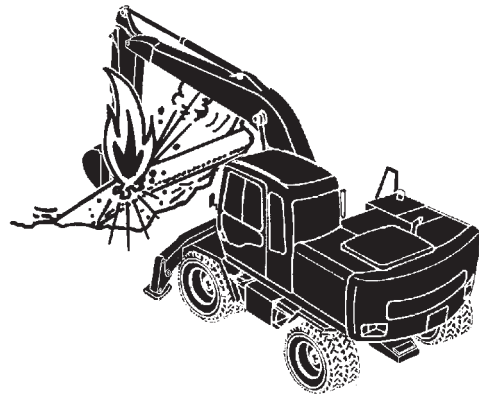

SA-086

### Operate with Caution

- If the front attachment or any other part of the machine hits against an overhead obstacle, such as a bridge, both the machine and the overhead obstacle will be damaged, and personal injury may result as well.
  - Take care to avoid hitting overhead obstacles with the boom or arm.

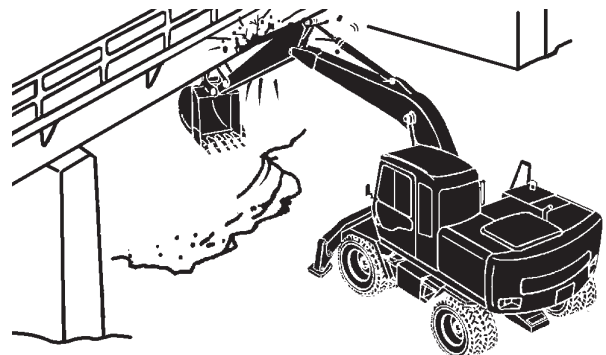

SA-087

## SAFETY

---

### Avoid Power Lines

- Serious injury or death can result if the machine or front attachments are not kept a safe distance from electric lines.
- When operating near an electric line, never move any part of the machine or load to within 3 m plus twice the line insulator length of overhead wires.
- Check and comply with any local regulations that may apply.
- Wet ground will expand the area that could cause any person on it to be affected by electric shock. Keep all bystanders or co-workers away from the site.



SA-089

---

### Precautions for Lightning

- Lightning may strike the machine.

If lightning comes close, immediately stop the operation, and take the following action.

- When you are around the machine or operating cab-less machine, evacuate to a safe place far away from the machine.
- When you are in the cab, stay in the cab until lightning has passed and safety is assured. Close the cab doors and windows. Lower the bucket to the ground, and stop the engine. Put your hands on your lap to avoid contact with any metal surfaces. Never go out of the cab.

If lightning strikes the machine or near the machine, check all of the machine safety devices for any failure after lightning has passed and safety is assured. If any trouble is found, operate the machine only after repairing it.



SA-1241

## SAFETY

---

### Object Handling

- If a lifted load should fall, any person nearby may be struck by the falling load or may be crushed underneath it, resulting in serious injury or death.
  - When using the machine for craning operations, be sure to comply with all local regulations.
  - Do not use damaged chains or frayed cables, slings, or ropes.
  - Before craning, position the upperstructure with the travel motors at the rear.
  - Move the load slowly and carefully. Never move it suddenly.
  - Keep all persons well away from the load.
  - Never move a load over a person's head.
  - Do not allow anyone to approach the load until it is safely and securely situated on supporting blocks or on the ground.
  - Never attach a sling or chain to the bucket teeth. They may come off, causing the load to fall.

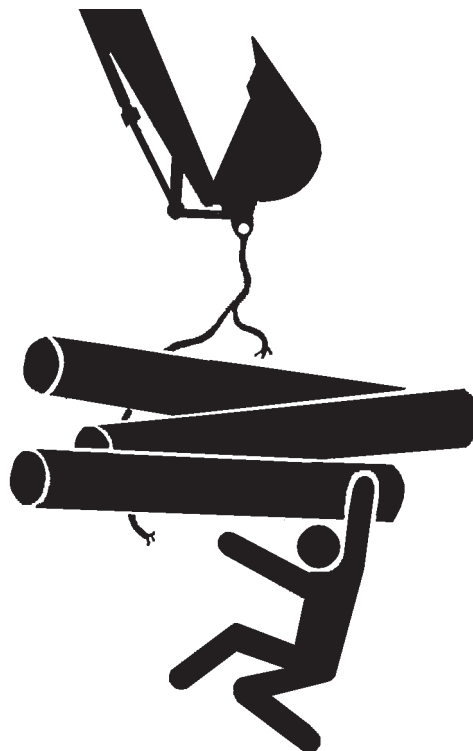

SA-014

### Protect Against Flying Debris

- If flying debris hit eyes or any other part of the body, serious injury may result.
  - Guard against injury from flying pieces of metal or debris; wear goggles or safety glasses.
  - Keep bystanders away from the working area before striking any object.
  - Always close the front windows, doors, door windows and the overhead window when operating the machine.

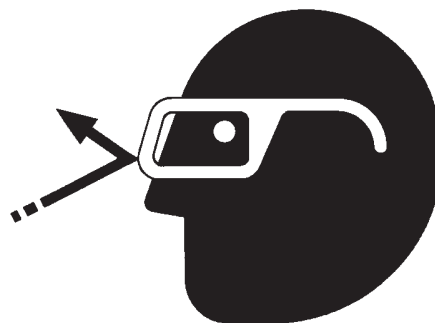

SA-432

## SAFETY

---

### Park Machine Safely

To avoid accidents:

1. Park the machine on a firm, level surface.
2. Lower the bucket and blade to the ground.
3. Pull the pilot control shut-off lever to the LOCK position.
4. Place the F-N-R switch in the neutral, and put the brake switch in the P (parking brake) position.
5. Turn auto-idle switch OFF.
6. Run the engine at slow idle speed without load for 5 minutes.
7. Turn key switch to OFF to stop engine.
8. Remove the key from the key switch.
9. Close windows, roof vent, and cab door.
10. Lock all access doors and compartments.
11. Secure the wheels with wedges.



SA-093

---

### Handle Fluids Safely—Avoid Fires

- Handle fuel with care; it is highly flammable. If fuel ignites, an explosion and/or a fire may occur, possibly resulting in serious injury or death.
  - Do not refuel the machine while smoking or when near open flame or sparks.
  - Always stop the engine before refueling the machine.
  - Fill the fuel tank outdoors.
- All fuels, most lubricants, and some coolants are flammable.
  - Store flammable fluids well away from fire hazards.
  - Do not incinerate or puncture pressurized containers.
  - Do not store oily rags; they can ignite and burn spontaneously.
  - Securely tighten the fuel and oil filler cap.



SA-018



SA-019

## SAFETY

### Transport Safely

- Take care the machine may turn over when loading or unloading the machine onto or off of a truck or trailer.
  - Observe the related regulations and rules for safe transportation.
  - Select an appropriate truck or trailer for the machine to be transported.
  - Be sure to use a signal person.
  - Always follow the following precautions for loading or unloading:
    1. Select solid and level ground.
    2. Always use a ramp or deck strong enough to support the machine weight.
    3. Turn auto-idle switch OFF.
    4. Always select the slow speed mode with the travel mode switch.
    5. Never load or unload the machine onto or off a truck or trailer using the front attachment functions when driving up or down the ramp.
    6. Never steer the machine while on the ramp. If the traveling direction must be changed while on the ramp, unload the machine from the ramp, reposition the machine on the ground, then try loading again.
    7. At the top end of the ramp where it meets the flatbed, there is a sudden bump. Take care when traveling over it.
    8. Place blocks in front of and behind the tires. Securely fasten the machine to the truck or trailer deck with wire ropes.

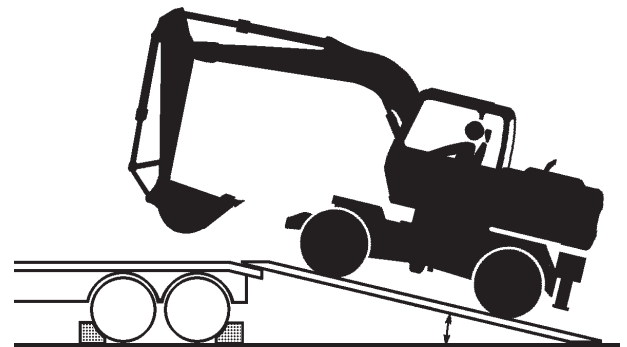

SA-094



SA-095

Be sure to further follow the details described in the "TRANSPORTING" chapter in the operator's manual.

## SAFETY

### Practice Safe Maintenance

To avoid accidents:

- Understand service procedures before starting work.
- Keep the work area clean and dry.
- Do not spray water or steam inside cab.
- Never lubricate or service the machine while it is moving.
- Keep hands, feet and clothing away from power-driven parts.

Before servicing the machine:

1. Park the machine on a firm, level surface.
2. Lower bucket to the ground.
3. Pull the pilot control shut-off lever to the LOCK position.
4. Place the F-N-R switch in the neutral, and put the brake switch in the P (parking brake) position.
5. Turn auto-idle switch OFF.
6. Run the engine at slow idle speed without load for 5 minutes.
7. Turn key switch to OFF to stop engine.
8. Remove the key from the key switch.
9. Close windows, roof vent, and cab door.
10. Lock all access doors and compartments.
11. Secure the wheels with wedges.

- If a maintenance procedure must be performed with the engine running, do not leave the machine unattended.
- If the machine must be raised, maintain a 90 to 110° angle between the boom and arm. Securely support any machine elements that must be raised for service work.
- Inspect certain parts periodically and repair or replace as necessary. Refer to the section discussing that part in the "MAINTENANCE" chapter in the operator's manual.
- Keep all parts in good condition and properly installed.
- Fix damage immediately. Replace worn or broken parts. Remove any buildup of grease, oil, or debris.
- When cleaning parts, always use nonflammable detergent oil. Never use highly flammable oil such as fuel oil and gasoline to clean parts or surfaces.
- Turn the battery disconnect switch to OFF before adjusting the electrical systems or performing welding on the machine.



SA-028



SA-527



## SAFETY

---

- Sufficiently illuminate the work site. Use a maintenance work light when working under or inside the machine.
- Always use a work light protected with a guard. If the light bulb is broken, spilled fuel, oil, antifreeze fluid, or window washer fluid may catch fire.



SA-037

---

### Warn Others of Service Work

- Unexpected machine movement can cause serious injury.
  - Before performing any work on the machine, attach a “Do Not Operate” tag on the control lever. This tag is available from your authorized dealer.

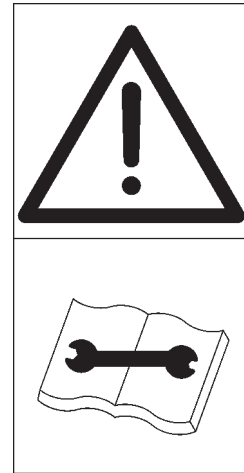

SS2045102-4

---

### Support Machine Properly

- Never attempt to work on the machine without securing the machine first.
  - Always lower the attachment to the ground before you work on the machine.
  - If you must work on a lifted machine or attachment, securely support the machine or attachment. Do not support the machine on cinder blocks, hollow tires, or props that may crumble under continuous load. Do not work under a machine that is supported solely by a jack.



SA-527

## SAFETY

---

### Stay Clear of Moving Parts

- Entanglement in moving parts can cause serious injury.
  - To prevent accidents, care should be taken to ensure that hands, feet, clothing, jewelry and hair do not become entangled when working around rotating parts.

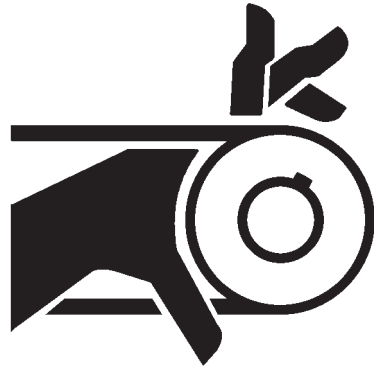

SA-026

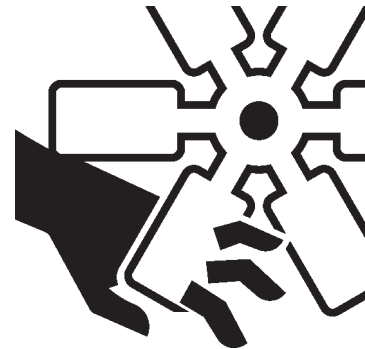

SA-2294

---

### Prevent Parts from Flying

- Travel reduction gears are under pressure.
  - As pieces may fly off, be sure to keep body and face away from AIR RELEASE PLUG to avoid injury.
  - GEAR OIL is hot. Wait for GEAR OIL to cool, then gradually loosen AIR RELEASE PLUG to release pressure.



SA-344

## SAFETY

---

### Avoid Injury from Attachment Falling Accident

- Stored attachments such as buckets, hydraulic hammers, and blades can fall and cause serious injury or death.
  - To avoid possible personal injury from attachment falling accident, use a platform when replacing an attachment.
  - Securely store attachments such as bucket, blade, breaker and other parts to prevent falling.
  - Keep children and bystanders away from attachment storage areas.

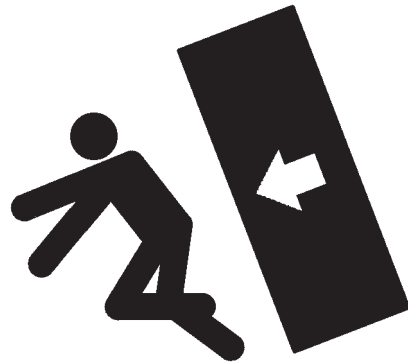

SA-034

---

### Support Maintenance Properly

- Explosive separation of a tire and rim parts can cause serious injury or death.
  - Do not attempt to mount a tire unless you have the proper equipment and experience to perform the job. Have it done by your authorized dealer or a qualified repair service.
  - Always maintain the correct tire pressure. DO NOT inflate tire above the recommended pressure.
  - When inflating tires, use a chip-on chuck and extension hose long enough to allow you to stand to one side and not in front of or over the tire assembly. Use a safety cage if available.
  - Inspect tires and wheels daily. Do not operate with low pressure, cuts bubbles, damaged rims, or missing lug bolts and nuts.
  - Never cut or weld on an inflated tire or rim assembly. Heat from welding could cause an increase in pressure and may result in tire explosion.

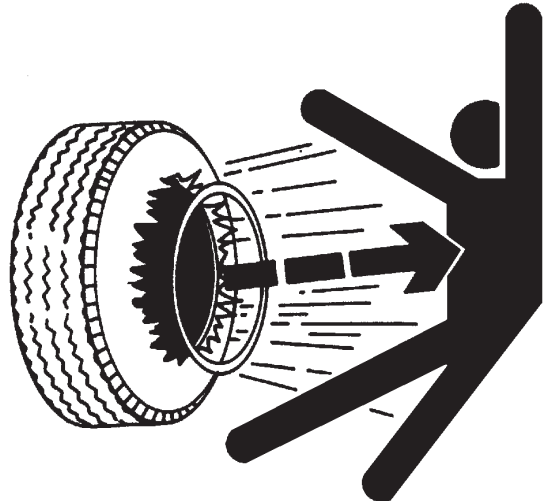

SA-249

## SAFETY

---

### Prevent Burns

Hot spraying fluids:

- After operation, engine coolant is hot and under pressure. Hot water or steam is contained in the engine, expansion tank and heater lines. Skin contact with escaping hot water or steam can cause severe burns.
  - Avoid possible injury from hot spraying water. **DO NOT** remove the expansion tank cap until the engine is cool. When opening, turn the cap slowly to the stop. Allow all pressure to be released before removing the cap.
  - The hydraulic oil tank is pressurized. Again, be sure to release all pressure before removing the cap.



SA-039

Hot fluids and surfaces:

- Engine oil, gear oil and hydraulic oil also become hot during operation. The engine, hoses, lines and other parts become hot as well.
  - Wait for the oil and components to cool before starting any maintenance or inspection work.



SA-225

---

### Replace Rubber Hoses Periodically

- Rubber hoses that contain flammable fluids under pressure may break due to aging, fatigue, and abrasion. It is very difficult to gauge the extent of deterioration due to aging, fatigue, and abrasion of rubber hoses by inspection alone.
  - Periodically replace the rubber hoses. (See the page of "Periodic replacement of parts" in the operator's manual.)
- Failure to periodically replace rubber hoses may cause a fire, fluid injection into skin, or the front attachment to fall on a person nearby, which may result in severe burns, gangrene, or otherwise serious injury or death.



SA-019

## SAFETY

### Avoid High-Pressure Fluids

- Fluids such as diesel fuel or hydraulic oil under pressure can penetrate the skin or eyes causing serious injury, blindness or death.
  - Avoid this hazard by relieving pressure before disconnecting hydraulic or other lines.
  - Tighten all connections before applying pressure.
  - Search for leaks with a piece of cardboard; take care to protect hands and body from high-pressure fluids. Wear a face shield or goggles for eye protection.
  - If an accident occurs, see a doctor familiar with this type of injury immediately. Any fluid injected into the skin must be surgically removed within a few hours or gangrene may result.



SA-031

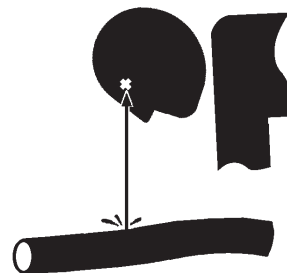

SA-292

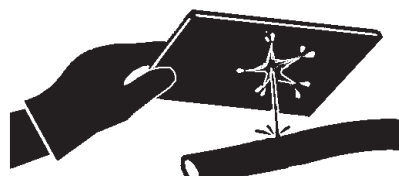

SA-044

### Prevent Fires

Check for Oil Leaks:

- Fuel, hydraulic oil and lubricant leaks can lead to fires.
  - Check for oil leaks due to missing or loose clamps, kinked hoses, lines or hoses that rub against each other, damage to the oil cooler, and loose oil cooler flange bolts.
  - Tighten, repair or replace any missing, loose or damaged clamps, lines, hoses, oil cooler and oil cooler flange bolts.
  - Do not bend or strike high-pressure lines.
  - Never install bent or damaged lines, pipes, or hoses.
  - Replace fuel hoses and hydraulic hoses periodically even if there is no abnormality in their external appearance.



SA-019

Check for Shorts:

- Short circuits can cause fires.
  - Clean and tighten all electrical connections.
  - Check before each shift or after eight (8) to ten (10) hours operation for loose, kinked, hardened or frayed electrical cables and wires.
  - Check before each shift or after eight (8) to ten (10) hours operation for missing or damaged terminal caps.
  - DO NOT OPERATE MACHINE if cable or wires are loose, kinked, etc.
  - Never attempt to modify electric wirings.

## SAFETY

---

### Clean up Flammable Materials:

- Spilled fuel and oil, trash, grease, debris, accumulated coal dust, and other flammable materials may cause fires.
  - Prevent fires by inspecting and cleaning the machine daily, and by removing adhered oil or accumulated flammable materials immediately. Check and clean high temperature parts such as the exhaust outlet and muffler earlier than the normal interval.
  - Do not wrap high temperature parts such as a muffler or exhaust pipe with oil absorbents.
  - Do not store oily cloths as they are vulnerable to catching fire.
  - Keep flammable materials away from open flames.
  - Do not ignite or crush a pressurized or sealed container.
  - Wire screens may be provided on openings on the engine compartment covers to prevent flammable materials such as dead leaves from entering. However, flammable materials which have passed through the wire screen may cause fires. Check and clean the machine every day and immediately remove accumulated flammable materials.

### Check Key Switch:

- If a fire breaks out, failure to stop the engine will escalate the fire, hampering fire fighting.
  - Always check key switch function before operating the machine every day:
    1. Start the engine and run it at slow idle.
    2. Turn the key switch to the OFF position to confirm that the engine stops.
  - If any abnormalities are found, be sure to repair them before operating the machine.

### Check Heat Shields:

- Damaged or missing heat shields may lead to fires.
  - Damaged or missing heat shields must be repaired or replaced before operating the machine.
  - If hydraulic hoses are broken while the engine cover is open, splattered oil on the high temperature parts such as muffler may cause fire. Always close the engine cover while operating the machine.

## SAFETY

---

### Evacuating in Case of Fire

- If a fire breaks out, evacuate the machine in the following way:
  - Stop the engine by turning the key switch to the OFF position if there is time.
  - Use a fire extinguisher if there is time.
  - Exit the machine.
- In an emergency, if the cab door or front window can not be opened, break the front or rear window pane with the emergency evacuation hammer to escape from the cab. Refer to the explanation pages on the Emergency Evacuation Method in the operator's manual.



SA-393



SS-1510

### Beware of Exhaust Fumes

- Prevent asphyxiation. Engine exhaust fumes can cause sickness or death.
  - If you must operate in a building, be sure there is adequate ventilation. Either use an exhaust pipe extension to remove the exhaust fumes or open doors and windows to bring enough outside air into the area.
  - White smoke may be generated during the aftertreatment device regeneration. Do not attempt to do aftertreatment device manual regeneration in a badly ventilated indoors.

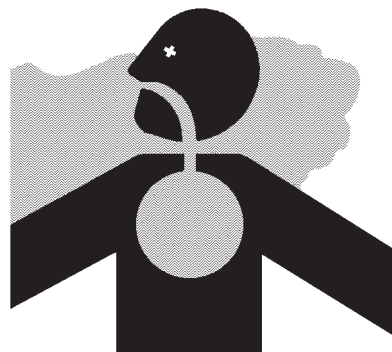

SA-016

## SAFETY

---

### Precautions for Welding and Grinding

- Welding may generate gas and/or small fires.
  - Be sure to perform welding in a well ventilated and prepared area. Store flammable materials in a safe place before starting welding.
  - Only qualified personnel should perform welding. Never allow an unqualified person to perform welding.
  - Turn the battery disconnect switch to the OFF position before performing welding on the machine.
- Grinding on the machine may create fire hazards. Store flammable materials in a safe place before starting grinding.
- After finishing welding and grinding, recheck that there are no abnormalities such as the area surrounding the welded area still smoldering.



SA-818



## SAFETY

---

### Avoid Heating Near Pressurized Fluid Lines

- Flammable spray can be generated by heating near pressurized fluid lines, resulting in severe burns to yourself and bystanders.
- Do not heat by welding, soldering, or using a torch near pressurized fluid lines or other flammable materials.
- Pressurized lines can be accidentally cut when heat goes beyond the immediate flame area. Install temporary fire-resistant guards to protect hoses or other materials before engaging in welding, soldering, etc..



SA-030

### Avoid Applying Heat to Lines Containing Flammable Fluids

- Do not weld or flame cut pipes or tubes that contain flammable fluids.
- Clean pipes and tubes thoroughly with non-flammable solvent before welding or flame cutting.

---

### Precautions for Handling Accumulator and Gas Damper

High-pressure nitrogen gas is sealed in the accumulator and the gas damper. Inappropriate handling may cause explosion, possibly resulting in serious injury or death.

Strictly comply with the following items:

- Do not disassemble the unit.
- Keep the units away from open flames and fire.
- Do not bore a hole, do not cut by torch.
- Avoid giving shocks by hitting or rolling the unit.
- Before disposing of the unit, sealed gas must be released. Consult your authorized dealer.

## SAFETY

---

### Remove Paint Before Welding or Heating

- Hazardous fumes can be generated when paint is heated by welding, soldering, or using a torch. If inhaled, these fumes may cause sickness.
  - Avoid potentially toxic fumes and dust.
  - Do all such work outside or in a well-ventilated area. Dispose of paint and solvent properly.
  - Remove paint before welding or heating:
    1. If you sand or grind paint, avoid breathing the dust. Wear an approved respirator.
    2. If you use solvent or paint stripper, remove stripper with soap and water before welding. Remove solvent or paint stripper containers and other flammable materials from area. Allow fumes to disperse at least 15 minutes before welding or heating.



SA-029

---

### Beware of Asbestos and Silica Dust and Other Contaminations

- Take care not to inhale dust produced in the work site. Inhalation of asbestos fibers may be the cause of lung cancer. Inhalation of silica dust or other contaminations may cause sickness.
  - Depending on the work site conditions, the risk of inhaling asbestos fiber, silica dust or other contaminations may exist. Spray water to prevent asbestos fibers, silica dust or other contaminations from becoming airborne. Do not use compressed air.
  - When operating the machine in a work site where asbestos fibers, silica dust or other contaminations might be present, be sure to operate the machine upwind, and wear a mask rated to prevent the inhalation of asbestos, silica dust or other contaminations.
  - Keep bystanders out of the work site during operation.
  - Asbestos fibers might be present in imitation parts. Use only genuine Hitachi Parts.



SA-029

## SAFETY

---

### Prevent Battery Explosions

- Battery gas can explode.
  - Keep sparks, lighted matches, and flame away from the top of battery.
  - Never check battery charge by placing a metal object across the posts. Use a voltmeter or hydrometer.
  - Do not charge a frozen battery; it may explode. Warm the battery to 16 °C ( 60 °F ) first.
  - Do not continue to use or charge the battery when electrolyte level is lower than specified. Explosion of the battery may result.
  - Loose terminals may produce sparks. Securely tighten all terminals.
  - Connect terminals to the correct electrical poles. Failure to do so may cause damage to the electrical parts or fire.
- Battery electrolyte is poisonous. If the battery should explode, battery electrolyte may be splashed into eyes, possibly resulting in blindness.
  - Be sure to wear eye protection when checking electrolyte specific gravity.



SA-032

---

### Service Air Conditioning System Safely

- If spilled onto skin, refrigerant may cause a cold contact burn.
  - Refer to the instructions described on the container for proper use when handling the refrigerant.
  - Use a recovery and recycling system to avoid leaking refrigerant into the atmosphere.
  - Never touch the refrigerant.



SA-405

## SAFETY

---

### Handle Chemical Products Safely

- Direct exposure to hazardous chemicals can cause serious injury. Potentially hazardous chemicals used with your machine include such items as lubricants, coolants, paints, and adhesives.
  - Safety Data Sheet (SDS) provides specific details on chemical products: physical and health hazards, safety procedures, and emergency response techniques.
  - Check the SDS before you start any job using a hazardous chemical. That way you will know exactly what the risks are and how to do the job safely. Then follow procedures and use recommended equipment.
  - See your authorized dealer for SDS's (available only in English) on chemical products used with your machine.



SA-2579

---

### Dispose of Waste Properly

- Improperly disposing of waste can threaten the environment and ecology. Potentially harmful waste used with Hitachi equipment includes such items as oil, fuel, coolant, DEF/AdBlue®, brake fluid, filters, and batteries.
  - Use leakproof containers when draining fluids. Do not use food or beverage containers that may mislead someone into drinking from them.
  - Do not pour waste onto the ground, down a drain, or into any water source.
  - Air conditioning refrigerants escaping into the air can damage the Earth's atmosphere. Government regulations may require a certified air conditioning service center to recover and recycle used air conditioning refrigerants.
  - Inquire on the proper way to recycle or dispose of waste from your local environmental or recycling center, or from your authorized dealer.

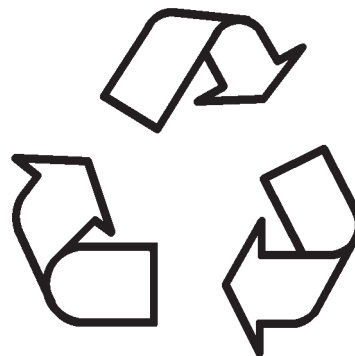

SA-226

## SAFETY

---

### Never Ride Attachment

Never allow anyone to ride on attachments or the load. This is an extremely dangerous practice.

---

### Notes on Aftertreatment Device

#### About Aftertreatment Device

The aftertreatment device filter removes particulate matter (PM) and NO<sub>x</sub> (Nitrogen Oxide) from the exhaust gas. Follow the instructions below to prevent the aftertreatment device from being damaged.

**Exhaust gas from aftertreatment device, muffler, exhaust piping and tail piping becomes hot during and right after engine running and regeneration of aftertreatment device. Keep away from the exhaust system or hot gas from the exhaust piping during regeneration. Be careful to avoid skin contact with exhaust gas. It may cause severe burns.**

- White smoke may be generated during aftertreatment device regeneration. Do not attempt to perform aftertreatment device manual regeneration in a badly ventilated area.
  - Do not touch water coming directly out of the aftertreatment device. The water is mildly-acidic by oxidation catalyst mounted in the aftertreatment device. If filter water spills on your skin, immediately flush it out with clean water.
- 

### Precautions for Communication Terminal

Electrical wave transmitted from the communication terminal may cause malfunction of other electronic devices. Inquire to the device manufacturer for information on electrical wave disturbance when using an electronic device near the communication terminal.

## SAFETY

### Precaution for Communication Terminal Equipment

This machine has a communication terminal equipment emitting electrical waves installed inside the rear tray situated at the back of the operator's seat. There is a possibility that a medical device, including an implantable device such as a cardiac pacemaker, could be affected and malfunction due the electrical waves emitted from the communication terminal equipment.

Any person fitted with a medical device such as the above should not use this machine, unless the medical device and the rear tray are at least 22 centimeters apart at all times. If this condition cannot be met, please contact your authorized dealer and have the person in charge stop the communication terminal equipment from functioning completely, and confirm that it is not emitting electrical waves.

This machine is equipped with a communication terminal type A or type B.

Consult your nearest authorized dealer for the type of communication terminal.

Specific Absorption Rate ("SAR") (measured by 10 g per unit) of communication terminal equipments:

	Type A	Type B
E-GSM900	0.573 W/kg (914.8 MHz)	0.12 W/kg (897.6 MHz)
DCS-1800	0.130 W/kg (1710.2 MHz)	0.06 W/kg (1748.0 MHz)
WCDMA Band I	0.271 W/kg (1950.0 MHz)	0.05 W/kg (1950.0 MHz)
WCDMA Band VIII	-	0.10 W/kg (892.6 MHz)

\*This data was measured by having each type of communication terminal equipment, such as the communication terminal equipment used with this machine, and a human body set apart by 3 cm.

\* SAR is a measure of the amount of radio frequency energy absorbed by the body when using a wireless application such as a mobile phone.

In Japan: \*Under the Japanese Radio Act and other relevant Japanese regulations, the maximum SAR value is 2 W/kg (as of March 2010).

In EU Member nation: \*Under the "Council Recommendation 1999/519/EC 12 July 1999"; the maximum SAR value is 2 W/kg (as of March 2010).

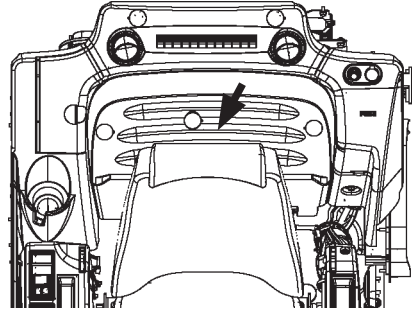

SA-2302

## SAFETY

---

- Do not attempt to disassemble, repair, modify and displace of the communication terminal, antenna and cables. Failure to do so may cause damage or fire on the machine and the communication terminal. (Before removing or installing the communication terminal, consult your authorized Hitachi dealer.)
- Do not pinch or forcibly pull cables, cords and connectors. Failure to do so may cause damage or fire on the machine and the communication terminal due to short/broken circuit.

## SAFETY

---

### Operation Stop Alarm (ZX140W-6/145W-6)

**The operation stop alarm (1) is displayed when there is a failure in the fuel circuit. The engine will stop 12 minutes after the error is generated to ensure safety.**

**Immediately stop the machine in a safe place, and consult your nearest authorized dealer.**

Suspended load work is especially dangerous, please stop it as quickly as possible.

After stopping the operation, drive the machine to firm, level ground where no possibility of falling stones, ground collapse, or floods are present.

(Refer to the section "Parking" in the DRIVING MACHINE chapter in the operator's manual.)

Be aware of vehicles following behind the machine. Slow down gradually. Maneuver the machine to the side of the road. Stop the machine, turn the brake switch to the "P" (parking) position and apply the parking brake. When any machine failure is recognized in a short tunnel, if possible park the machine upon exiting the tunnel.

Use a sign to indicate that the vehicle is disabled. Unless a sign is used, collision with a vehicle following behind may result, so be sure to indicate the vehicle is disabled using one of the following methods. Also display a sign in the same fashion if unable to stop the vehicle in a safe place.

- Use a parking signboard.
- Turn the hazard lights ON.
- Use an emergency signal instrument (emergency signal light).
- Use a red flag or light.
- Tie a piece of cloth like a handkerchief to an easy-to-see place such as the door or the rear end of the machine.



MLAB-04-009



## SAFETY

### Notes on Protection of Operator's Station when the Machine Rolls Over

The cab corresponds to the structure to protect the operator by absorbing impact energy when the machine rolls over (Roll-Over Protective Structure (ROPS)).

However, when modifying the machine or installing a special attachment causing the machine mass to exceed the maximum operating mass described in the ROPS certification, the cab cannot fulfill its protective function, possibly causing serious injury or death.

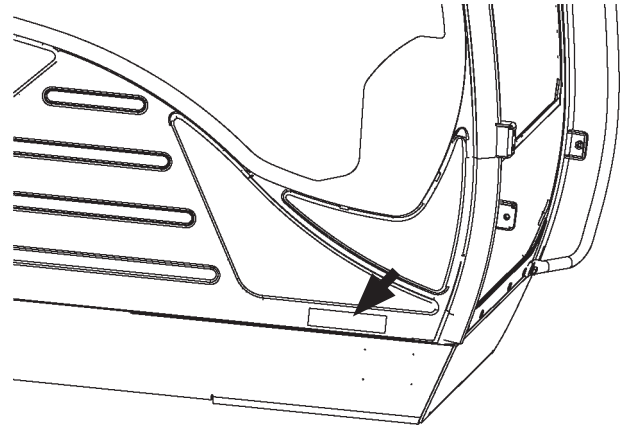

SS-3636

In order to safeguard the protective structure, follow the instructions below.

- Consult your authorized dealer before welding parts or drilling a hole on the cab, which possibly reduces the cab strength.
- Be sure to always fasten the seat belt when operating the machine. If the machine rolls over without operator fastening the seat belt, the operator may become injured, may be thrown out from the cab and/or may become crushed under the machine even though the cab has the protective structure.

The ROPS certification is valid under the following conditions.

- The machine mass is lower than the maximum operating mass described in the ROPS certification.
- The ROPS is properly installed.
- No modification is made to the ROPS.
- The ROPS is free from damage.

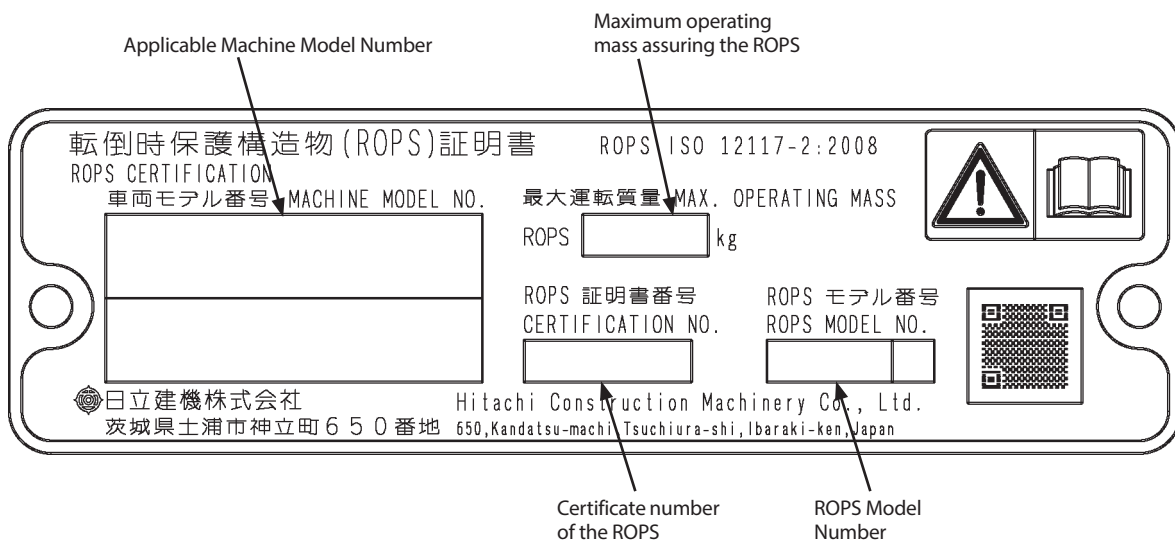

SS-3671

## SAFETY

---

### Before Returning the Machine to the Customer

- After maintenance or repair work is complete, confirm that:
  - The machine is functioning properly, especially the safety systems.
  - Worn or damaged parts have been repaired or replaced.



SA-435

# SECTION AND GROUP CONTENTS

## WORKSHOP MANUAL

---

### SECTION 1 GENERAL INFORMATION

<b>Group 1 Precautions for Disassembling and Assembling</b>
<b>Group 2 Tightening</b>
<b>Group 3 Painting</b>
<b>Group 4 Bleeding Air</b>
<b>Group 5 Preparation</b>

### SECTION 2 MAINTENANCE STANDARD

<b>Group 1 Upperstructure</b>
<b>Group 3 Front Attachment</b>

### SECTION 3 UPPERSTRUCTURE

<b>Group 1 Cab</b>
<b>Group 2 Counterweight</b>
<b>Group 3 Main Frame</b>
<b>Group 4 Engine</b>
<b>Group 8 Pump Device</b>
<b>Group 9 Control Valve</b>
<b>Group 10 Swing Device</b>
<b>Group 11 Pilot Valve</b>
<b>Group 12 Solenoid Valve</b>
<b>Group 13 Signal Control Valve</b>
<b>Group 14 Aftertreatment Device</b>
<b>Group 15 DEF Tank</b>
<b>Group 16 Coolant Control Valve</b>
<b>Group 17 DEF Supply Module</b>
<b>Group 21 Shockless Valve</b>
<b>Group 22 Electric Lever</b>
<b>Group 23 Steering Valve</b>
<b>Group 24 Brake Valve</b>
<b>Group 25 Accumulator Charging Valve</b>
<b>Group 26 Accumulator Manifold</b>

All information, illustrations and specifications in this manual are based on the latest product information available at the time of publication. The right is reserved to make changes at any time without notice.



**Thanks for your reading.**

**Please click here to download complete manual instantly.**

**And can also choose other manuals.**

**Feel free --->write to me with any questions.**

**Our service email:**

**manuals007@hotmail.com**