

Workshop Manual

ZW 150-5B 150PL-5B Wheel Loader

ZW150-5B • ZW150PL-5B WHEEL LOADER WORKSHOP MANUAL

 **Hitachi Construction Machinery Co., Ltd.**

URL:<http://www.hitachi-c-m.com>

INTRODUCTION

To The Reader

This manual is written for an experienced technician to provide technical information needed to maintain and repair this machine.

The machine specification and description according to destination may be explained on this manual.

- Be sure to thoroughly read this manual for correct product information and service procedures.

- If you have any questions or comments, at if you found any errors regarding the contents of this manual, please contact using "Service Manual Revision Request Form" at the end of this manual. (Note: Do not tear off the form. Copy it for usage.):

- Technical Information Center Hitachi Construction Machinery Co., Ltd.
- TEL: 81-29-832-7084
- FAX: 81-29-831-1162
- E-mail: HCM-TIC-GES@hitachi-kenki.com

Additional References

Please refer to the other materials (operator's manual, parts catalog, engine technical material and Hitachi training material etc.) in addition to this manual.

Manual Composition

This manual consists the Technical Manual, the Workshop Manual and the Engine Manual.

- Information included in the Technical Manual: Technical information needed for redelivery and delivery, operation and activation of all devices and systems, operational performance tests, and troubleshooting procedures.

- Information included in the Workshop Manual: Technical information needed for maintenance and repair of the machine, tools and devices needed for maintenance and repair, maintenance standards, and removal / installation and assemble / disassemble procedures.

- Information included in the Engine Manual: Technical information needed for redelivery and delivery and maintenance and repair of the machine, operation and activation of all devices and systems, troubleshooting and assemble / disassemble procedures.

Page Number

Each page has a number, located on the center lower part of the page, and each number contains the following information:

Example:

- Technical Manual: T 1-3-5

T	Technical Manual
1	Section Number
3	Group Number
5	Consecutive Page Number for Each Group

- Workshop Manual: W 1-3-2-5

W	Workshop Manual
1	Section Number
3	Group Number
2	Sub Group Number
5	Consecutive Page Number for Each Group

INTRODUCTION

Safety Alert Symbol and Headline Notations

In this manual, the following safety alert symbol and signal words are used to alert the reader to the potential for personal injury of machine damage.

 This is the safety alert symbol. When you see this symbol, be alert to the potential for personal injury. Never fail to follow the safety instructions prescribed along with the safety alert symbol. The safety alert symbol is also used to draw attention to component/part weights. To avoid injury and damage, be sure to use appropriate lifting techniques and equipment when lifting heavy parts.

CAUTION:

Indicates potentially hazardous situation which could, if not avoided, result in personal injury or death.

IMPORTANT:

Indicates a situation which, if not conformed to the instructions, could result in damage to the machine.

NOTE:

Indicates supplementary technical information or know-how.

Units Used

SI Units (International System of Units) are used in this manual. MKSA system units and English units are also indicated in parentheses just behind SI units.

Example: 24.5 MPa (250 kgf/cm², 3560 psi)

A table for conversion from SI units to other system units is shown below for reference purposes.

Quantity	To Convert From	Into	Multiply By
Length	mm	in	0.03937
	mm	ft	0.003281
Volume	L	US gal	0.2642
	L	US qt	1.057
	m ³	yd ³	1.308
Weight	kg	lb	2.205
Force	N	kgf	0.10197
	N	lbf	0.2248
Torque	N·m	kgf·m	0.10197
Pressure	MPa	kgf/cm ²	10.197
	MPa	psi	145.0
Power	kW	PS	1.360
	kW	HP	1.341
Temperature	°C	°F	°C×1.8+32
Velocity	km/h	mph	0.6214
	min ⁻¹	rpm	1.0
Flow rate	L/min	US gpm	0.2642
	mL/rev	cc/rev	1.0

 NOTE: The numerical value in this manual might be different from the above-mentioned table.

SYMBOL AND ABBREVIATION

Symbol and Abbreviation

Symbol / Abbreviation	Name	Explanation
TO	Technical manual (Operational principle)	Technical manual (Operational Principle).
TT	Technical manual (Troubleshooting)	Technical manual (Troubleshooting).
T/M	Technical manual	Technical manual.
W, W/M	Workshop manual	Workshop manual (Removal and Installation, Disassembly and Assembly).
MC	Main Controller	Main controller. MC controls the engine, and valve amount according to the machine operating condition.
ECM	Engine Control Module	Engine controller. ECM controls fuel injection amount according to the machine operating condition.
VGS	Variable Geometry System controller	Variable turbo controller. VGS is an exhaust turbo charged system to supercharge the exhaust energy while running the engine at slow idle speed. VGS optimizes the turbine rotation, improves the performance at slow-speed torque and the acceleration, reduces fuel consumption, and reduces particulate matter (PM) by adjusting the nozzle opening of turbine housing.
HST Controller	Hydrostatic Transmission Controller	Hydrostatic transmission controller. HST controller control transmission, HST pump and HST motor 1, 2 according to the machine operating condition.
GSM	Global System for Mobile communications controller	Communication controller. GSM is a type of wireless communication system, is used in more than on 100 countries around Europe and Asia, and becomes the factual global standards of the mobile telephone.
GPS	Global Positioning System	Global positioning system.
CAN	Controller Area Network	CAN communication. CAN is a serial communications protocol internationally-standardized by ISO (International Organization for Standardization).
A/C	Air Conditioner	Air conditioner.
OP, OPT	Option	Optional component.
MPDr.	Maintenance Pro Dr.	MPDr. is software that troubleshooting, monitoring, and adjustment.
A/I	Auto-Idle	Auto-idle.
WU	Warming-Up	Warming-up.
Li	Low (Slow) Idle	Slow idle engine speed.
ATT	Attachment	Attachment.

SYMBOL AND ABBREVIATION

Symbol / Abbreviation	Name	Explanation
DPF	Diesel Particulate Filter	DPF is a filter which removes particulate matter (PM) including the toxic substance of exhaust gas of the diesel engine. Exhaust particulate removal equipment.
DPD	Diesel Particulate Diffuser	DPD is an exhaust emission control system, a type of DPF, which cleans up particulate matter (PM) of diesel engine exhaust gas. DPD is a ceramic filter which traps and filters PM of exhaust gas. DPD burns up accumulated PM when PM increases and regenerates the filter.
DOC	Diesel Oxidation Catalyst	Oxidation catalyst for the diesel engine. Diesel oxidation catalyst oxidizes unburnt fuel and raises exhaust temperature.
CSF	Catalyzed Soot Filter	Filter. The filter traps, burns, and remove particulate matter (PM) by using high-temperature-exhaust gas with diesel oxidation catalyst. Catalyst is applied onto the filter. This advances PM burning.
PM	Particulate Matter	Particulate matter.
EGR	Exhaust Gas Recirculation	The EGR control re-circulates a part of exhaust gas in the intake manifold and combines it with intake-air. Therefore, combustion temperature is lowered and generation of oxide of nitrogen (NO _x) is controlled.

SAFETY

Recognize Safety Information

- These are the **SAFETY ALERT SYMBOLS**.
 - When you see these symbols on your machine or in this manual, be alert to the potential for personal injury.
 - Follow recommended precautions and safe operating practices.



SA-688

Understand Signal Words

- On machine safety signs, signal words designating the degree or level of hazard - **DANGER**, **WARNING**, or **CAUTION** - are used with the safety alert symbol.
 - **DANGER** indicates an imminently hazardous situation which, if not avoided, will result in death or serious injury.
 - **WARNING** indicates a potentially hazardous situation which, if not avoided, could result in death or serious injury.
 - **CAUTION** indicates a potentially hazardous situation which, if not avoided, may result in minor or moderate injury.
 - **DANGER or WARNING safety signs** are located near specific hazards. General precautions are listed on **CAUTION safety signs**.
 - Some safety signs do not use any of the designated signal words above after the safety alert symbol are occasionally used on this machine.
- **CAUTION** also calls attention to safety messages in this manual.
- To avoid confusing machine protection with personal safety messages, a signal word **IMPORTANT** indicates a situation which, if not avoided, could result in damage to the machine.
-  **NOTE** indicates an additional explanation for an element of information.



IMPORTANT



SA-1223

SAFETY

Follow Safety Instructions

- Carefully read and follow all safety signs on the machine and all safety messages in this manual.
- Safety signs should be installed, maintained and replaced when necessary.
 - If a safety sign or this manual is damaged or missing, order a replacement from your authorized dealer in the same way you order other replacement parts (be sure to state machine model and serial number when ordering).
- Learn how to operate the machine and its controls correctly and safely.
- Allow only trained, qualified, authorized personnel to operate the machine.
- Keep your machine in proper working condition.
 - Unauthorized modifications of the machine may impair its function and/or safety and affect machine life.
 - Do not modify any machine parts without authorization. Failure to do so may deteriorate the part safety, function, and/or service life. In addition, personal accident, machine trouble, and/or damage to material caused by unauthorized modifications will void Hitachi Warranty Policy.
 - Never attempt to modify or disassemble the inlet/exhaust parts and the muffler filter. Avoid giving shocks on the muffler filter by striking elements with other objects or dropping the elements. Failure to do so may affect the exhaust gas purifying device, possibly damaging it or lowering its performance.
 - Do not use attachments and/or optional parts or equipment not authorized by Hitachi. Failure to do so may deteriorate the safety, function, and/or service life of the machine. In addition, personal accident, machine trouble, and/or damage to material caused by using unauthorized attachments and/or optional parts or equipment will void Hitachi Warranty Policy.
- The safety messages in this SAFETY chapter are intended to illustrate basic safety procedures of machines. However it is impossible for these safety messages to cover every hazardous situation you may encounter. If you have any questions, you should first consult your supervisor and/or your authorized dealer before operating or performing maintenance work on the machine.



SA-003

SAFETY

Prepare for Emergencies

- Be prepared if a fire starts or if an accident occurs.
 - Keep a first aid kit and fire extinguisher on hand.
 - Thoroughly read and understand the label attached on the fire extinguisher to use it properly.
 - To ensure that a fire extinguisher can be always used when necessary, check and service the fire extinguisher at the recommended intervals as specified in the fire extinguisher manual.
 - Establish emergency procedure guidelines to cope with fires and accidents.
 - Keep emergency numbers for doctors, ambulance service, hospital, and fire department posted near your telephone.



SA-437

Wear Protective Clothing

- Wear close fitting clothing and safety equipment appropriate to the job.

You may need:

- A hard hat
- Safety shoes
- Safety glasses, goggles, or face shield
- Heavy gloves
- Hearing protection
- Reflective clothing
- Wet weather gear
- Respirator or filter mask.

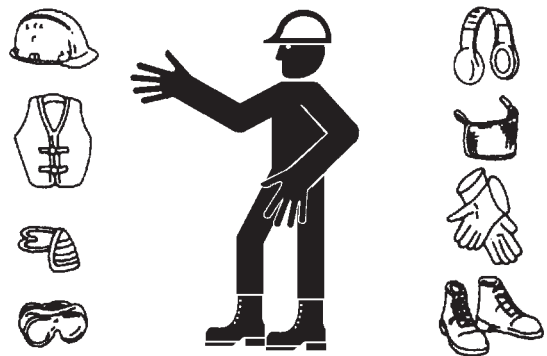

SA-438

Be sure to wear the correct equipment and clothing for the job. Do not take any chances.

- Avoid wearing loose clothing, jewelry, or other items that can catch on control levers or other parts of the machine.
- Operating equipment safely requires the full attention of the operator. Do not wear radio or music headphones while operating the machine.

SAFETY

Protect Against Noise

- Prolonged exposure to loud noise can cause impairment or loss of hearing.
- Wear a suitable hearing protective device such as earmuffs or earplugs to protect against objectionable or uncomfortably loud noises.



SA-434

Inspect Machine

- Inspect your machine carefully each day or shift by walking around it before you start it to avoid personal injury.
- In the walk-around inspection, be sure to cover all points described in the “Inspect Machine Daily Before Starting” section in the operator’s manual.



SA-435

SAFETY

General Precautions for Cab

- Before entering the cab, thoroughly remove all dirt and/or oil such as mud, grease, soil or stones that may mess up the cab from the soles of your work boots. If any controls such as a pedal is operated while with dirt and/or oil on the soles of the operator's work boots, the operator's foot may slip off the pedal, possibly resulting in a personal accident.
- Do not mess up around the operator's seat with parts, tools, soil, stones, obstacles that may fold up or turn over, cans or lunch box. The levers or pedals become inoperable if obstacle jams in operation stroke of the accelerator pedal, brake pedals, control lever lock switch or control levers, which may result in serious injury or death.
- Avoid storing transparent bottles in the cab. Do not attach any transparent type window decorations on the windowpanes as they may focus sunlight, possibly starting a fire.
- Refrain from listening to the radio, or using music headphones or mobile telephones in the cab while operating the machine.
- Keep all flammable objects and/or explosives away from the machine.
- After using the ashtray, always cover it to extinguish the match and/or tobacco.
- Do not leave cigarette lighters in the cab. When the temperature in the cab increases, the lighter may explode.
- Use proper floor mat dedicated to the machine. If another floor mat is used, it may be displaced and contact with the accelerator or brake pedals during operation, resulting in serious injury or death.

SAFETY

Use Handrails and Steps

- Falling is one of the major causes of personal injury.
 - When you get on and off the machine, always face the machine and maintain a three-point contact with the steps and handrails.
- Do not use any controls as handholds.
- Never jump on or off the machine. Never mount or dismount a moving machine.
- Be careful of slippery conditions on platforms, steps, and handrails when leaving the machine.
- Never get on and off the machine with tools in your hands.



SA-439

Never Ride Attachment

- Never allow anyone to ride attachment or the load. This is an extremely dangerous practice.

Adjust Operator's Seat

- A poorly adjusted seat for either the operator or the work at hand may quickly fatigue the operator leading to misoperations.
 - The seat should be adjusted whenever changing the operator for the machine.
 - The operator should be able to fully depress the pedals and to correctly operate the control levers with his back against the seat back.
 - If not, move the seat forward or backward, and check again.
 - Adjust the rear view mirror position so that the best rear visibility is obtained from the operator's seat. If the mirror is broken, immediately replace it with a new one.



SA-462

SAFETY

Ensure Safety Before Rising from or Leaving Operator's Seat

- Before rising from the operator's seat to open / close either side window or to adjust the seat position, be sure to first lower the front attachment to the ground and then move the control lever lock switch to the lock (🔒) position. Failure to do so may allow the machine to unexpectedly move when a body part unintentionally comes in contact with a control lever, possibly resulting in serious personal injury or death.
- Before leaving the machine, be sure to first lower the front attachment to the ground and then move the control lever lock switch to the lock (🔒) position. Turn the key switch OFF to stop the engine.
- Before leaving the machine, close all windows, doors, and access covers and lock them up.

Fasten Your Seat Belt

- If the machine should overturn, the operator may become injured and / or thrown from the cab. Additionally the operator may be crushed by the overturning machine, resulting in serious injury or death.
- Prior to operating the machine, thoroughly examine webbing, buckle and attaching hardware. If any item is damaged or worn, replace the seat belt or component before operating the machine.
- Be sure to remain seated with the seat belt securely fastened at all times when the machine is in operation to minimize the chance of injury from an accident.
- We recommend that the seat belt be replaced every four years regardless of its apparent condition.



SA-237

SAFETY

Move and Operate Machine Safely

- Bystanders can be run over.
 - Take extra care not to run over bystanders. Confirm the location of bystanders before moving, or operating the machine.
 - Always keep the travel alarm and horn in working condition (if equipped). It warns people when the machine starts to move.
 - Use a signal person when moving, or operating the machine in congested areas. Coordinate hand signals before starting the machine.
 - Use appropriate illumination. Check that all lights are operable before operating the machine. If any faulty illumination is present, immediately repair it.
 - Ensure the cab door, windows, doors and covers are securely locked.
 - Check the mirrors and the monitor in the CAB for problems.
If there is any problem, replace the problem part(s) or clean the mirror, camera and the monitor.
Refer to Rear View Monitor section on the cleaning of the camera and the monitor.



SA-398

Handle Starting Aids Safely

Starting fluid:

- Starting fluid is highly flammable.
 - Keep all sparks and flame away when using it.
 - Keep starting fluid well away from batteries and cables.
 - Remove container from machine if engine does not need starting fluid.
 - To prevent accidental discharge when storing a pressurized container, keep the cap on the container, and store it in a cool, well-protected location.
 - Do not incinerate or puncture a starting fluid container.



SA-293

SAFETY

Operate Only from Operator's Seat

- Inappropriate engine starting procedures may cause the machine to runaway, possibly resulting in serious injury or death.
 - Start the engine only when seated in the operator's seat.
 - NEVER start the engine while standing on the tire or on ground.
 - Do not start engine by shorting across starter terminals.
 - Before starting the engine, confirm that all control levers are in neutral.
 - Before starting the engine, confirm the safety around the machine and sound the horn to alert bystanders.



SA-431

Jump Starting

- Battery gas can explode, resulting in serious injury.
 - If the engine must be jump started, be sure to follow the instructions shown in the "OPERATING ENGINE" chapter in the operator's manual.
 - The operator must be in the operator's seat so that the machine will be under control when the engine starts. Jump starting is a two-person operation.
 - Never use a frozen battery.
 - Failure to follow correct jump starting procedures could result in a battery explosion or a runaway machine.



SA-032

SAFETY

Investigate Job Site Beforehand

- When working at the edge of an excavation or on a road shoulder, the machine could tip over, possibly resulting in serious injury or death.
- Investigate the configuration and ground conditions of the job site beforehand to prevent the machine from falling and to prevent the ground, stockpiles, or banks from collapsing.
- Make a work plan. Use machines appropriate to the work and job site.
- Reinforce ground, edges, and road shoulders as necessary. Keep the machine well back from the edges of excavations and road shoulders.
- When working on an incline or on a road shoulder, employ a signal person as required.
- Confirm that your machine is equipped with a FOPS cab before working in areas where the possibility of falling stones or debris exist.
- When the footing is weak, reinforce the ground before starting work.
- When working on frozen ground, be extremely alert. As ambient temperatures rise, footing becomes loose and slippery.
- Beware the possibility of fire when operating the machine near flammable objects such as dry grass.



SA-447

SAFETY

Equipment of Head Guard, ROPS, FOPS

In case the machine is operated in areas where the possibility of falling stones or debris exist, equip a head guard, ROPS, or FOPS according to the potential hazardous conditions. (The standard cab for this machine corresponds to ROPS and FOPS.) Any modification of the ROPS structure will modify its performances and its certification will be lost.

ROPS: Roll-Over Protective Structure

FOPS: Falling Object Protective Structure

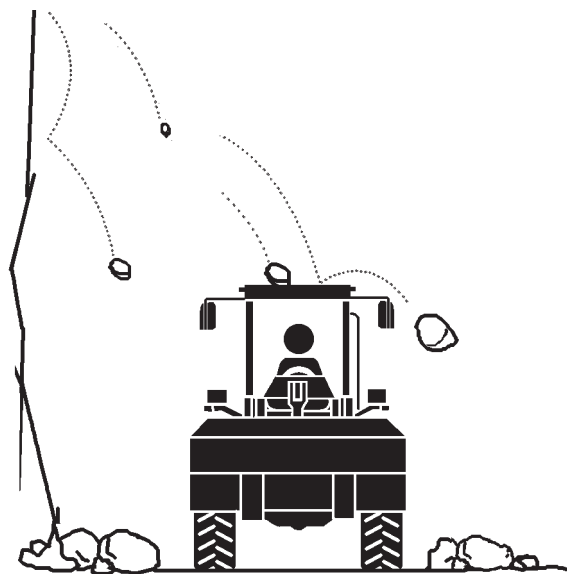

SA-521

Provide Signals for Jobs Involving Multiple Machines

- For jobs involving multiple machines, provide signals commonly known by all personnel involved. Also, appoint a signal person to coordinate the job site. Make sure that all personnel obey the signal person's directions.



SA-481

SAFETY

Keep Riders Off Machine

- Riders on machine are subject to injury such as being struck by foreign objects and being thrown off the machine.
- Only the operator should be on the machine. Keep riders off.
- Riders also obstruct the operator's view, resulting in the machine being operated in an unsafe manner.



SA-427

Drive Safely

- Beware of the possibility of slipping and / or turning over the machine when driving on a slope.
- When driving on level ground, hold the bucket at mark (A) 300 mm (12 in) above the ground as illustrated.
- Avoid traveling over any obstacles.
- Drive the machine slowly when driving on rough terrain.
- Avoid quick direction changes. Failure to do so may cause the machine to turn over.
- If the engine stops while driving, the steering function becomes inoperative. Immediately stop the machine by applying the brake to prevent personal accident.

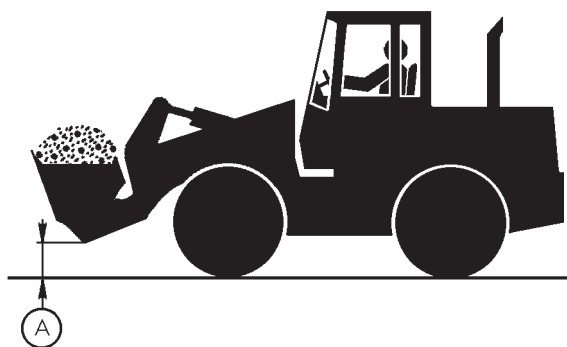

SA-448

SAFETY

Drive Machine Safely (Work Site)

- Before driving the machine, always confirm that the steering wheel / and forward / reverse lever (switch) direction corresponds to the direction you wish to drive.
 - Be sure to detour around any obstructions.
- Driving on a slope may cause the machine to slip or overturn, possibly resulting in serious injury or death.
 - When driving up or down a slope, keep the bucket facing the direction of travel, approximately 200 to 300 mm (approximately 8 to 12 in) (A) above the ground.
 - If the machine starts to skid or becomes unstable, immediately lower the bucket to the ground and stop.
- Driving across the face of a slope or steering on a slope may cause the machine to skid or overturn. If the direction must be changed, move the machine to level ground, then, change the direction to ensure safe operation.



SA-449

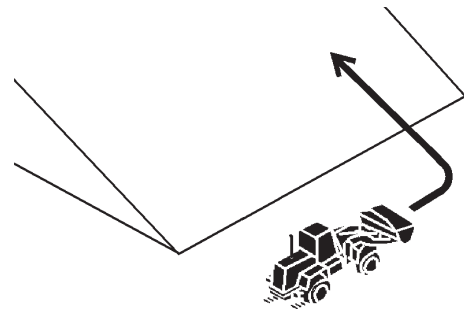

SA-450

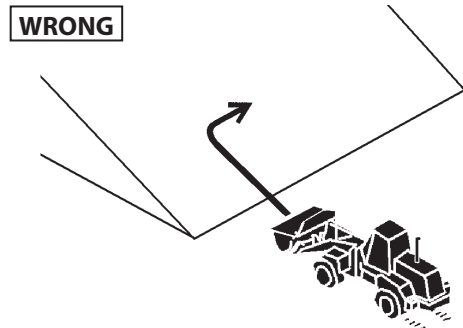

SA-451

SAFETY

Drive Safely with Bucket Loaded

- If the machine is incorrectly operated while driving with the bucket loaded, turning over of the machine may result. Be sure to follow all the instructions indicated below.
 - When driving the machine on a job site with the bucket loaded, hold the bucket as low as possible to keep the machine balanced and to have good visibility.
 - Do not exceed the rated load capacity. Always operate the machine within the rated load capacity.
 - Avoid fast starts, stops, and quick turns. Failure to do so may result in personal injury and / or death.
 - Avoid rapid drive direction changes which could possibly cause personal injury and / or death.



SA-400

Drive on Snow Safely

- Beware of the possibility of slipping or turning over the machine when driving on frozen snow surfaces.
 - The machine may slip more easily than expected on frozen snow surfaces even if the inclination is small. Reduce speed when driving. Avoid fast starts, stops and quick turns.
 - Road shoulder and / or set-up utilities covered with snow are difficult to locate. Be sure where they are before removing snow.
 - Be sure to use tire chains when driving on snow.
 - Avoid applying the brake for quick stops on snow. If a quick stop is required, lower the bucket to the ground.

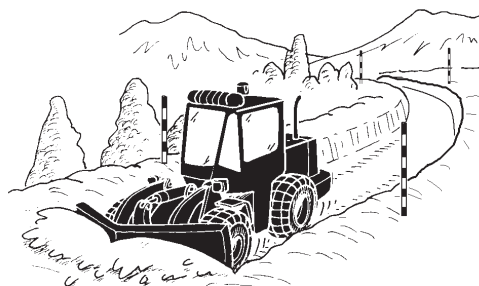

SA-452

SAFETY

Travel on Public Roads Safely

- This machine is not allowed to drive on public roads with the bucket loaded.
- Be sure to empty the bucket.
- Hold the bucket at mark (A) 300 mm (12 in) above the road surface as illustrated.

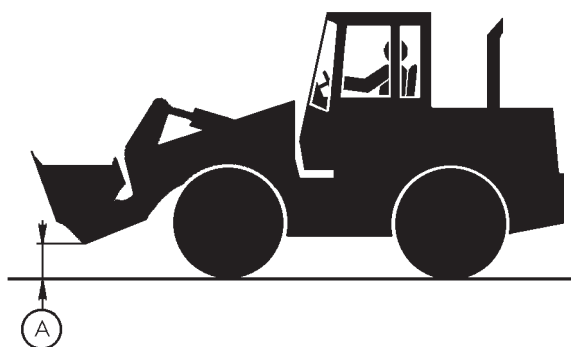

SA-453

Avoid Injury from Rollaway Accidents

- Death or serious injury may result if you attempt to mount or stop a moving machine.

To avoid rollaways:

- Select level ground when possible to park machine.
- Do not park the machine on a grade.
- Lower the bucket to the ground.
- Put the forward / reverse lever (switch) in neutral, and pull up the parking brake switch (lever) in the ON (parking brake) position.
- Run the engine at low idle speed without load for 5 minutes to cool down the engine.
- Stop the engine and remove the key from the key switch.
- Turn the control lever lock switch to the lock (🔒) position.
- Block both tires and lower the bucket to the ground.
- Position the machine to prevent rolling.
- Park at a reasonable distance from other machines.



SA-457

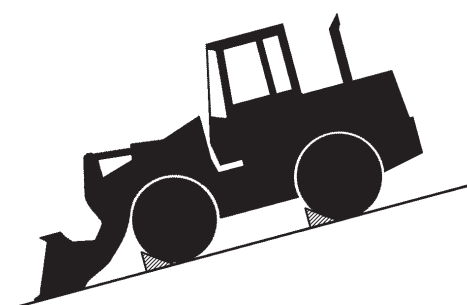

SA-458

SAFETY

Avoid Accidents from Backing Up and Turning

- Make sure no one is working under or close to the machine before backing up or turning the machine to avoid personal injury and / or death by being run over or entangled in the machine.
- Keep all personnel away from the machine by sounding the horn and / or using hand signals. Use extra care to be sure no one is in from the articulation area before turning the machine.
- Keep windows, mirrors, and lights in good condition.
- Reduce travel speed when dust, heavy rain, fog, etc., reduce the visibility.
- In case good visibility is not obtained, use a signal person to guide you.



SA-383



SA-312

SAFETY

Avoid Positioning Bucket or Attachment Over Anyone

- Never allow the bucket or attachment to pass over co-workers and / or the dump truck operator's cab. Falling soil from the bucket or contact with bucket or attachment may cause serious personal accidents and / or damage to the machine.
- Avoid carrying the bucket or attachment over the co-workers to ensure safe operation.



SA-518

Avoid Tipping

DO NOT ATTEMPT TO JUMP CLEAR OF TIPPING MACHINE. MACHINE WILL TIP OVER FASTER THAN YOU CAN JUMP FREE, POSSIBLY RESULTING IN SERIOUS PERSONAL INJURY OR DEATH. IF TIPPING OVER OF THE MACHINE IS PREDICTED, SECURELY HOLD THE STEERING WHEEL TO PREVENT YOUR BODY FROM BEING THROWN OUT OF THE MACHINE.

MACHINE WILL TIP OVER FASTER THAN YOU CAN JUMP FREE

FASTEN YOUR SEAT BELT

- The danger of tipping is always present when operating on a grade, possibly resulting in serious injury or death.

To avoid tipping:

- Be extra careful before operating on a grade.
 - Prepare machine operating area flat.
 - Keep the bucket low to the ground and close to the machine.
 - Reduce operating speeds to avoid tipping or slipping.
 - Avoid changing direction when traveling on grades.
 - NEVER attempt to travel across a grade steeper than 5 degrees if crossing the grade is unavoidable.
 - Reduce swing speed as necessary when swinging loads.
- Be careful when working on frozen ground.
 - Temperature increases will cause the ground to become soft and make ground travel unstable.

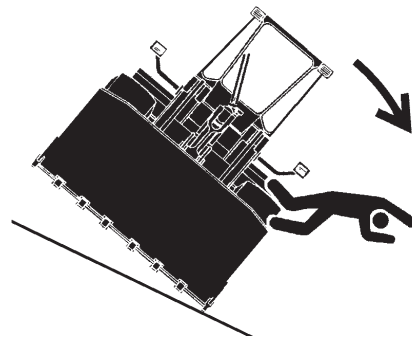

SA-463

SAFETY

Never Undercut a High Bank

- The edges could collapse or a land slide could occur causing serious injury or death.



SA-519

Dig with Caution

- Accidental severing of underground cables or gas lines may cause an explosion and / or fire, possibly resulting in serious injury or death.
 - Before digging, check the location of cables, gas lines, and water lines.
 - Keep the minimum distance required, by law, from cables, gas lines, and water lines.
 - If a fiber optic cable should be accidentally severed, do not look into the end. Doing so may result in serious eye injury.
 - Contact your local "diggers hot line" if available in your area, and / or the utility companies directly. Have them mark all underground utilities.



SA-396

Perform Truck Loading Safely

- Do not operate the machine involuntarily. Unexpected machine movement may cause personal injury and / or death.
 - Do not lower the bucket with the lift arm control lever in the FLOAT position. The bucket may free fall, possibly causing personal injury and / or death.
 - Always select a level surface for truck loading.



SA-397

SAFETY

Avoid Power Lines

Serious injury or death can result from contact with electric lines.

Never move any part of the machine or load closer to any electric line than 3 m (10 ft) plus twice the line insulator length.

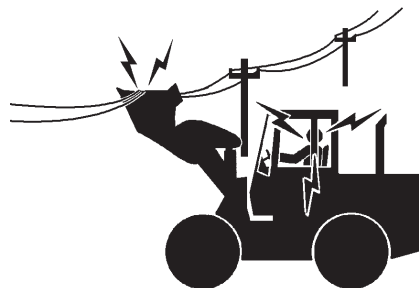

SA-455

Precautions for Operation

- If the front attachment or any part of the machine comes in contact with an overhead obstacle, both the machine and the overhead obstacle may become damaged, and personal injury may result.
 - Take care to avoid coming in contact with overhead obstacles with the bucket or arm during operation.

Precautions for Lightning

- The machine is vulnerable to lightning strikes.
 - In the event of an electrical storm, immediately stop operation, and lower the bucket to the ground. Evacuate to a safe place far away from the machine.
 - After the electrical storm has passed, check all of the machine safety devices for any failure. If any failed safety devices are found, operate the machine only after repairing them.

SAFETY

Object Handling

CRANING OPERATION USING THE MACHINE IS NOT ALLOWED.

- If a lifted load should fall, any person nearby may be struck by the falling load or may be crushed underneath it, resulting in serious injury or death.

Never attach a sling or chain to the bucket teeth or to the attachment (fork or grapple for example). They may come off, causing the load to fall.



SA-132

Protect Against Flying Debris

- If flying debris hit eyes or any other part of the body, serious injury may result.
 - Guard against injury from flying pieces of metal or debris; wear goggles or safety glasses.
 - Keep bystanders away from the working area before striking any object.

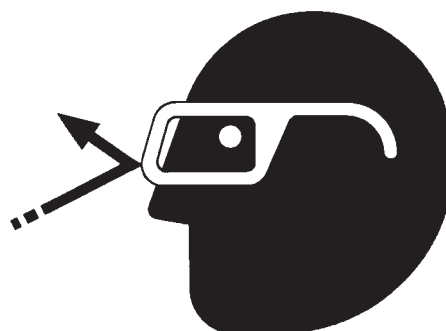

SA-432

SAFETY

Park Machine Safely

To avoid accidents:

- Park the machine on a firm, level surface.
- Lower bucket to the ground.
- Put the forward / reverse lever (switch) in neutral, and turn the parking brake switch (lever) ON (parking brake) position.
- Run the engine at low idle speed without load for 5 minutes.
- Turn key switch to OFF to stop engine.
- Remove the key from the key switch.
- Turn the control lever lock switch to the lock (🔒) position.
- Close windows, roof vent, and cab door.
- Lock all access doors and compartments.



SA-456

Store Attachments Safely

- Stored attachments such as buckets, hydraulic hammers, and blades can fall and cause serious injury or death.
- Securely store attachments and implements to prevent falling. Keep children and bystanders away from storage areas.

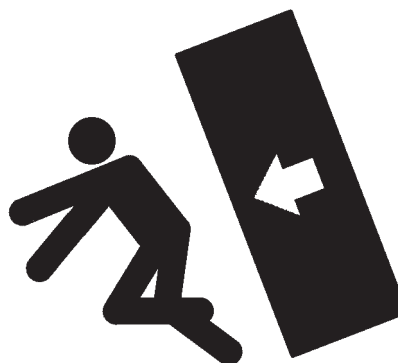

SA-034

SAFETY

Transport Safely

- Take care that the machine may turn over when loading or unloading the machine onto or off of a truck or trailer.
 - Observe the related regulations and rules for safe transportation.
 - Select an appropriate truck or trailer for the machine to be transported.
 - Be sure to use a signal person.
 - Always follow the following precautions for loading or unloading:
 1. Select solid and level ground.
 2. Always use a ramp or deck strong enough to support the machine weight.
 3. Use the low speed gear.
 4. Never steer the machine while being on the ramp. If the traveling direction must be changed while being on the ramp, unload the machine from the ramp, reposition the machine on the ground, then try loading again.
 5. After loading, install the lock bar to securely hold the articulation mechanism.
 6. Wedge the front and rear of tires. Securely hold the machine to the truck or trailer deck with wire ropes.

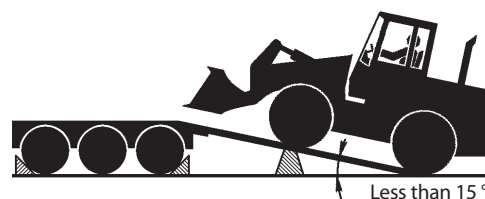

SA-454

Be sure to further follow the details described in the TRANSPORTING chapter.

SAFETY

Handle Fluids Safely—Avoid Fires

- Handle fuel with care; it is highly flammable. If fuel ignites, an explosion and / or a fire may occur, possibly resulting in serious injury or death.
 - Do not refuel the machine while smoking or when near open flame or sparks.
 - Always stop the engine before refueling the machine.
 - Fill the fuel tank outdoors.
- All fuels, most lubricants, and some coolants are flammable.
 - Store flammable fluids well away from fire hazards.
 - Do not incinerate or puncture pressurized containers.
 - Do not store oily rags; they can ignite and burn spontaneously.
 - Securely tighten the fuel and oil filler caps.



SA-018



SA-019

SAFETY

Practice Safe Maintenance

To avoid accidents:

- Understand service procedures before starting work.
- Keep the work area clean and dry.
- Do not spray water or steam inside cab.
- Never lubricate or service the machine while it is moving.
- Keep hands, feet and clothing away from power-driven parts.

Before servicing the machine:

1. Park the machine on a level surface.
2. Lower the bucket to the ground.
3. Run the engine at low idle speed without load for 5 minutes.
4. Turn the key switch to OFF to stop engine.
5. Relieve the pressure in the hydraulic system by moving the control levers several times.
6. Remove the key from the key switch.
7. Attach a "Do Not Operate" tag on the control lever.
8. Turn the control lever lock switch to the lock (🔒) position.
9. Lock bar connects the front and rear frames.
10. Allow the engine to cool.

- If a maintenance procedure must be performed with the engine running, do not leave machine unattended.
- Never work under a machine raised by the lift arm.
- Inspect certain parts periodically and repair or replace as necessary. Refer to the section discussing that part in the "MAINTENANCE" chapter of this manual.
- Keep all parts in good condition and properly installed.
- Fix damage immediately. Replace worn or broken parts. Remove any buildup of grease, oil, or debris.
- When cleaning parts, always use nonflammable detergent oil. Never use highly flammable oil such as fuel oil and gasoline to clean parts or surfaces.
- Disconnect battery ground cable (-) before making adjustments to electrical systems or before performing welding on the machine.



SA-028



SA-312



SA-134



SA-527

SAFETY

- Sufficiently illuminate the work site. Use a maintenance work light when working under or inside the machine.
- Always use a work light protected with a guard. In case the light bulb is broken, spilled fuel, oil, antifreeze fluid, or window washer fluid may catch fire.



SA-037

Warn Others of Service Work

- Unexpected machine movement can cause serious injury.
- Before performing any work on the machine, attach a “Do Not Operate” tag on the control lever. This tag is available from your authorized dealer.

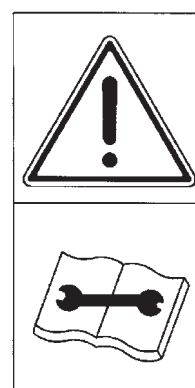

SS2045102

Support Machine Properly

- Never attempt to work on the machine without securing the machine first.
- Always lower the attachment to the ground before you work on the machine.
- If you must work on a lifted machine or attachment, securely support the machine or attachment. Do not support the machine on cinder blocks, hollow tires, or props that may crumble under continuous load. Do not work under a machine that is supported solely by a jack.



SA-527

SAFETY

Stay Clear of Moving Parts

- Entanglement in moving parts can cause serious injury.
- To prevent accidents, care should be taken to ensure that hands, feet, clothing, jewelry and hair do not become entangled when working around rotating parts.

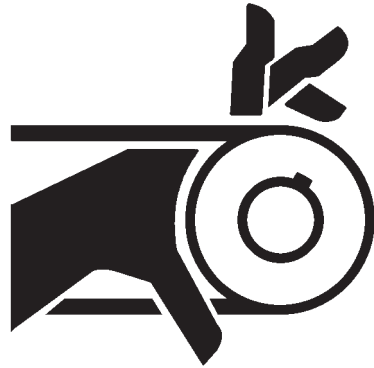

SA-026

Support Maintenance Properly

- Explosive separation of a tire and rim parts can cause serious injury or death.
- Do not attempt to mount a tire unless you have the proper equipment and experience to perform the job. Have it done by your authorized dealer or a qualified repair service.
- Always maintain the correct tire pressure. DO NOT inflate tire above the recommended pressure.
- When inflating tires, use a chip-on chuck and extension hose long enough to allow you to stand to one side and not in front of or over the tire assembly. Use a safety cage if available.
- Inspect tires and wheels daily. Do not operate with low pressure, cuts bubbles, damaged rims, or missing lug bolts and nuts.
- Never cut or weld on an inflated tire or rim assembly. Heat from welding could cause an increase in pressure and may result in tire explosion.

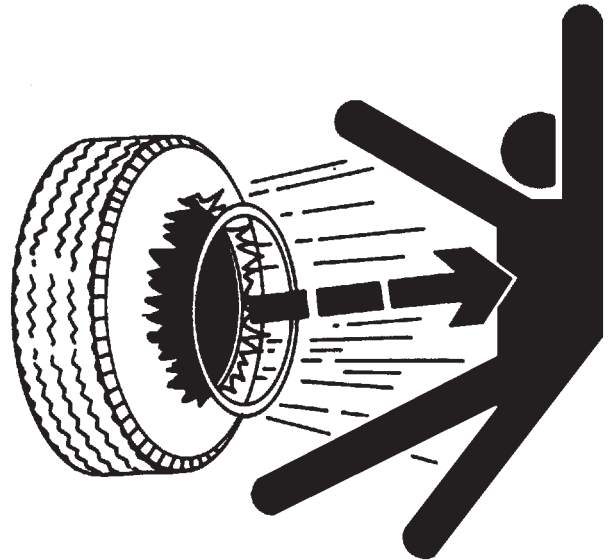

SA-249

SAFETY

Prevent Parts from Flying

- Travel reduction gears are under pressure.
 - As pieces may fly off, be sure to keep body and face away from AIR RELEASE PLUG to avoid injury.
 - GEAR OIL is hot. Wait for GEAR OIL to cool, then gradually loosen AIR RELEASE PLUG to release pressure.



SA-344

Prevent Burns

Hot spraying fluids:

- After operation, engine coolant is hot and under pressure. Hot water or steam is contained in the engine, radiator and heater lines. Skin contact with escaping hot water or steam can cause severe burns.
 - Avoid possible injury from hot spraying water. DO NOT remove the radiator cap until the engine is cool. When opening, turn the cap slowly to the stop. Allow all pressure to be released before removing the cap.
 - The hydraulic oil tank is pressurized. Again, be sure to release all pressure before removing the cap.



SA-039

Hot fluids and surfaces:

- Engine oil, gear oil and hydraulic oil also become hot during operation. The engine, hoses, lines and other parts become hot as well.
 - Wait for the oil and components to cool before starting any maintenance or inspection work.



SA-225

SAFETY

Replace Rubber Hoses Periodically

- Rubber hoses that contain flammable fluids under pressure may break due to aging, fatigue, and abrasion. It is very difficult to gauge the extent of deterioration due to aging, fatigue, and abrasion of rubber hoses by inspection alone.
- Periodically replace the rubber hoses. (See the page of "Periodic replacement of parts" in the operator's manual.)
- Failure to periodically replace rubber hoses may cause a fire, fluid injection into skin, or the front attachment to fall on a person nearby, which may result in severe burns, gangrene, or otherwise serious injury or death.



SA-019

Avoid High-Pressure Fluids

- Fluids such as diesel fuel or hydraulic oil under pressure can penetrate the skin or eyes causing serious injury, blindness or death.
- Avoid this hazard by relieving pressure before disconnecting hydraulic or other lines.
- Tighten all connections before applying pressure.
- Search for leaks with a piece of cardboard; take care to protect hands and body from high-pressure fluids. Wear a face shield or goggles for eye protection.
- If an accident occurs, see a doctor familiar with this type of injury immediately. Any fluid injected into the skin must be surgically removed within a few hours, or gangrene may result.



SA-031



SA-292

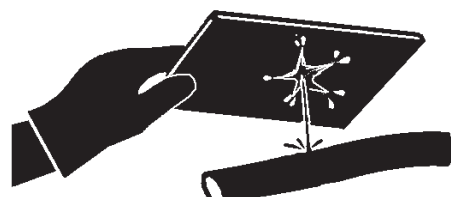

SA-044

SAFETY

Prevent Fires

Check for Oil Leaks:

- Fuel, hydraulic oil and lubricant leaks can lead to fires.
 - Check for oil leaks due to missing or loose clamps, kinked hoses, lines or hoses that rub against each other, damage to the oil-cooler, and loose oil-cooler flange bolts.
 - Tighten, repair or replace any missing, loose or damaged clamps, lines, hoses, oil-cooler and oil-cooler flange bolts.
 - Do not bend or strike high-pressure lines.
 - Never install bent or damaged lines, pipes, or hoses.
 - Replace fuel hoses and hydraulic hoses periodically even if there is no abnormality in their external appearance.



SA-019

Check for Shorts:

- Short circuits can cause fires.
 - Clean and tighten all electrical connections.
 - Check before each shift or after eight (8) to ten (10) hours operation for loose, kinked, hardened or frayed electrical cables and wires.
 - Check before each shift or after eight (8) to ten (10) hours operation for missing or damaged terminal caps.
 - DO NOT OPERATE MACHINE if cable or wires are loose, kinked, etc.
 - Never attempt to modify electric wirings.

SAFETY

Clean up Flammables:

- Spilled fuel and oil, and trash, grease, debris, accumulated coal dust, and other flammables may cause fires.
 - Prevent fires by inspecting and cleaning the machine daily, and by removing adhered oil or accumulated flammables immediately. Check and clean high temperature parts such as the exhaust outlet and mufflers earlier than the normal interval.
 - Do not wrap high temperature parts such as a muffler or exhaust pipe with oil absorbents.
 - Do not store oily cloths as they are vulnerable to catching fire.
 - Keep flammables away from open flames.
 - Do not ignite or crush a pressurized or sealed container.
 - Wire screens may be provided on openings on the engine compartment covers to prevent flammables such as dead leaves from entering. However, flammables which have passed through the wire screen may cause fires. Check and clean the machine every day and immediately remove accumulated flammables.

Check Key Switch:

- If a fire breaks out, failure to stop the engine will escalate the fire, hampering fire fighting.
Always check key switch function before operating the machine every day:
 1. Start the engine and run it at low idle.
 2. Turn the key switch to the OFF position to confirm that the engine stops.
- If any abnormalities are found, be sure to repair them before operating the machine.

Check Heat Shields:

- Damaged or missing heat shields may lead to fires.
 - Damaged or missing heat shields must be repaired or replaced before operating the machine.
 - If hydraulic hoses are broken while the engine cover is open, splattered oil on the high temperature parts such as mufflers may cause fire. Always close the engine cover while operating the machine.

SAFETY

Evacuating in Case of Fire

- If a fire breaks out, evacuate the machine in the following way:
 - Stop the engine by turning the key switch to the OFF position if there is time.
 - Use a fire extinguisher if there is time.
 - Exit the machine.
- In an emergency, if the cab door can not be opened, break the front or rear window panes with the emergency evacuation hammer to escape from the cab. Refer to the explanation pages on the Emergency Evacuation Method.



SA-393



SS-1510

Beware of Exhaust Fumes

- Prevent asphyxiation. Engine exhaust fumes can cause sickness or death.
 - If you must operate in a building, be sure there is adequate ventilation. Either use an exhaust pipe extension to remove the exhaust fumes or open doors and windows to bring enough outside air into the area.
 - PM (Particle Matter) combustion may generate white smoke during muffler filter regeneration. Do not attempt to do muffler filter manual regeneration in a badly ventilated indoors.

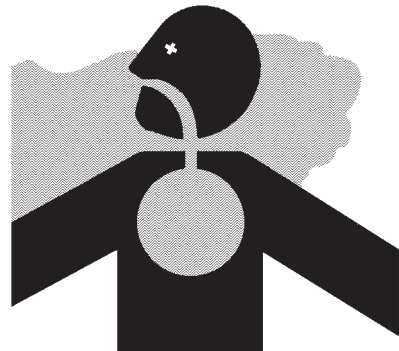

SA-016

Precautions for Welding and Grinding

- Welding may generate gas and / or small fires.
 - Be sure to perform welding in a well ventilated and prepared area. Store flammable objects in a safe place before starting welding.
 - Only qualified personnel should perform welding. Never allow an unqualified person to perform welding.
- Grinding on the machine may create fire hazards. Store flammable objects in a safe place before starting grinding.
- After finishing welding and grinding, recheck that there are no abnormalities such as the area surrounding the welded area still smoldering.

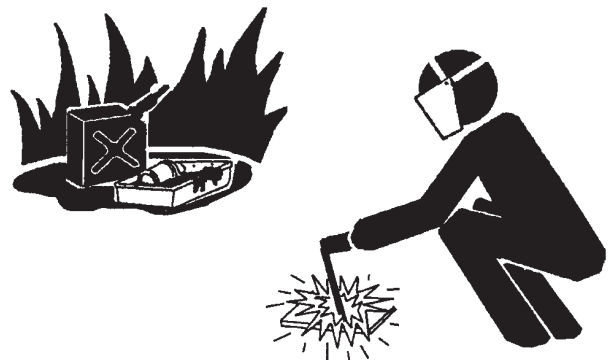

SA-818

SAFETY

Avoid Heating Near Pressurized Fluid Lines

- Flammable spray can be generated by heating near pressurized fluid lines, resulting in severe burns to yourself and bystanders.
- Do not heat by welding, soldering, or using a torch near pressurized fluid lines or other flammable materials.
- Pressurized lines can be accidentally cut when heat goes beyond the immediate flame area. Install temporary fire-resistant guards to protect hoses or other materials before engaging in welding, soldering, etc..



SA-030

Avoid Applying Heat to Lines Containing Flammable Fluids

- Do not weld or flame cut pipes or tubes that contain flammable fluids.
- Clean them thoroughly with nonflammable solvent before welding or flame cutting them.

Precautions for Handling Accumulator and Gas Damper

High-pressure nitrogen gas is sealed in the accumulator and the gas damper. Inappropriate handling may cause explosion, possibly resulting in serious injury or death.

Strictly comply with the following items:

- Do not disassemble the unit.
- Keep the units away from open flames and fire.
- Do not bore a hole, do not cut by torch.
- Avoid giving shocks by hitting or rolling the unit.
- Before disposing the unit, sealed gas must be released. Consult your nearest Hitachi dealer.

SAFETY

Remove Paint Before Welding or Heating

- Hazardous fumes can be generated when paint is heated by welding, soldering, or using a torch. If inhaled, these fumes may cause sickness.
 - Avoid potentially toxic fumes and dust.
 - Do all such work outside or in a well-ventilated area. Dispose of paint and solvent properly.
 - Remove paint before welding or heating:
1. If you sand or grind paint, avoid breathing the dust. Wear an approved respirator.
 2. If you use solvent or paint stripper, remove stripper with soap and water before welding. Remove solvent or paint stripper containers and other flammable material from area. Allow fumes to disperse at least 15 minutes before welding or heating.



SA-029

Beware of Asbestos and Silicon Dust and Other Contamination

- Take care not to inhale dust produced in the work site. Inhalation of asbestos fibers may be the cause of lung cancer. Inhalation of silicon dust and other contamination may cause sickness.
 - Depending on the work site conditions, the risk of inhaling asbestos fiber, silicon dust or other contamination may exist. Spray water to prevent asbestos fibers, silicon dust or other contamination from becoming airborne. Do not use compressed air.
 - When operating the machine in a work site where asbestos fibers, silicon dust or other contamination might be present, be sure to operate the machine from the upwind side and wear a mask rated to prevent the inhalation of asbestos, silicon dust or other contamination.
 - Keep bystanders out of the work site during operation.
 - Asbestos might be present in imitation parts. Use only genuine Hitachi Parts.



SA-029

SAFETY

Prevent Battery Explosions

- Battery gas can explode.
 - Keep sparks, lighted matches, and flame away from the top of battery.
 - Never check battery charge by placing a metal object across the posts. Use a voltmeter or hydrometer.
 - Do not charge a frozen battery; it may explode. Warm the battery to 16 °C (60 °F) first.
 - Do not continue to use or charge the battery when electrolyte level is lower than specified. Explosion of the battery may result.
 - Loose terminals may produce sparks. Securely tighten all terminals.
 - Connect terminals to the correct electrical poles. Failure to do so may cause damage to the electrical parts or fire.
- Battery electrolyte is poisonous. If the battery should explode, battery electrolyte may be splashed into eyes, possibly resulting in blindness.
 - Be sure to wear eye protection when checking electrolyte specific gravity.



SA-032

Service Air Conditioning System Safely

- If spilled onto skin, refrigerant may cause a cold contact burn.
 - Refer to the instructions described on the container for proper use when handling the refrigerant.
 - Use a recovery and recycling system to avoid leaking refrigerant into the atmosphere.
 - Never touch the refrigerant.



SA-405

SAFETY

Handle Chemical Products Safely

- Direct exposure to hazardous chemicals can cause serious injury. Potentially hazardous chemicals used with your machine include such items as lubricants, coolants, paints, and adhesives.
- A Material Safety Data Sheet (MSDS) provides specific details on chemical products: physical and health hazards, safety procedures, and emergency response techniques.
- Check the MSDS before you start any job using a hazardous chemical. That way you will know exactly what the risks are and how to do the job safely. Then follow procedures and use recommended equipment.
- See your authorized dealer for MSDS's (available only in English) on chemical products used with your machine.



SA-309

Dispose of Waste Properly

- Improperly disposing of waste can threaten the environment and ecology. Potentially harmful waste used with HITACHI equipment includes such items as oil, fuel, coolant, brake fluid, filters, and batteries.
- Use leakproof containers when draining fluids. Do not use food or beverage containers that may mislead someone into drinking from them.
- Do not pour waste onto the ground, down a drain, or into any water source.
- Air conditioning refrigerants escaping into the air can damage the Earth's atmosphere. Government regulations may require a certified air conditioning service center to recover and recycle used air conditioning refrigerants.
- Inquire on the proper way to recycle or dispose of waste from your local environmental or recycling center, or from your authorized dealer.

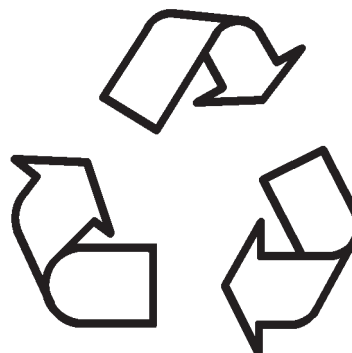

SA-226

SAFETY

Notes for Muffler Filter

Muffler Filter

The muffler filter removes particle matters (PM) in the exhaust gas. The muffler filter traps PM, and it is automatically regenerated by burning PM when the set amount of PM is accumulated in the filter. Follow the instructions below to prevent the muffler filter from being damaged.

⚠ WARNING: Exhaust gas from the muffler filter, muffler and exhaust piping becomes hot during and right after engine running and filter regeneration (burning PM). Keep away from the direction of the exhaust piping and its vicinity during the filter regeneration. Be careful not to let your skin contact with any hot gas from the exhaust piping. It may cause severe burns.

Do not directly touch water coming out of the muffler filter. The water is mildly-acidic by oxidation catalyst mounted in the muffler filter. If filter water spills on your skin, immediately flush it out with clean water.

Precautions for Communication Terminal

Electrical wave transmitted from the communication terminal may cause malfunction of other electronic devices. Inquire the device manufacturer for electrical wave disturbance upon using an electronic device near the communication terminal.

SAFETY

Precaution for Communication Terminal Equipment

This machine has a communication terminal equipment emitting electrical waves installed inside a rear tray which is situated at the back of the driver's seat. There is a possibility that a medical device, including an implantable device such as a cardiac pacemaker, would be affected and would malfunction by the electrical waves emitted from the communication terminal equipment.

Any person affixed with a medical device such as the above should not use this machine, unless the medical device and the rear tray are at least 22 centimeters (8.662 inches) apart at all times. If such condition cannot be met, please contact our company's nearest dealer and have the person in charge stop the communication terminal equipment from functioning completely and confirm that it is not emitting electrical waves.

Specific Absorption Rate ("SAR") (measured by 10 g per unit) of communication terminal equipments:

E-GSM900	0.573 W/Kg (914.80 MHz)
DCS-1800	0.130 W/Kg (1710.20 MHz)
WCDMA Band I	0.271 W/Kg (1950.00 MHz)

* This data was measured by having each type of communication terminal equipment, such as the communication terminal equipment used with this machine, and a human body set apart by 3 cm (1.18 inches).

* SAR is a measure of the amount of radio frequency energy absorbed by the body when using a wireless application such as a mobile phone.

In Japan: * Under the Japanese Radio Act and other relevant Japanese regulations, the maximum SAR value is 2 W/kg (as of March 2010).

In EU Member nation: * Under the "Council Recommendation 1999/519/EC 12 July 1999"; the maximum SAR value is 2 W/kg (as of March 2010).

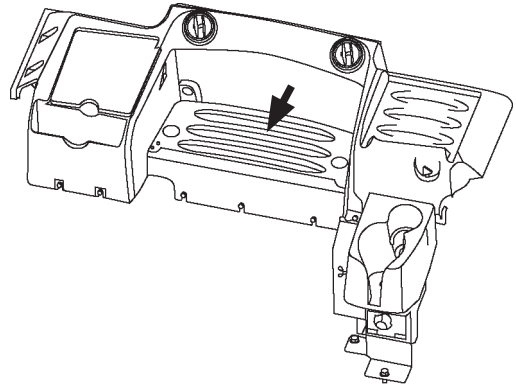

MNEC-01-046

SAFETY

- Never attempt to disassemble, repair, modify or displace the communication terminal, antennas or cables. Failure to do so may result in damage and/or fire to the base machine or to the communication terminal. (When required to remove or install the communication terminal, consult your nearest Hitachi dealer.)
- Do not pinch or forcibly pull cables, cords or connectors. Failure to do so may cause short circuit or broken circuit that may result in damage and/or fire to the base machine or to the communication terminal.

SAFETY

Before Returning the Machine to the Customer

- After maintenance or repair work is complete, confirm that:
 - The machine is functioning properly, especially the safety systems.
 - Worn or damaged parts have been repaired or replaced.



SA-435

SAFETY

(Blank)

SECTION AND GROUP CONTENTS

WORKSHOP MANUAL

SECTION 1 GENERAL INFORMATION

Group 1 Precautions for Disassembling and Assembling
Group 2 Tightening
Group 3 Painting
Group 4 Bleeding Air
Group 5 Releasing Pressure
Group 6 Preparation

SECTION 2 MAINTENANCE STANDARD

Group 1 Body
Group 2 Travel System
Group 3 Front Attachment
Group 4 Front Attachment (Parallel Link)

SECTION 3 BODY

Group 1 Cab
Group 2 Counterweight
Group 3 Center Hinge
Group 4 Engine
Group 5 Radiator Assembly
Group 6 Hydraulic Oil Tank
Group 7 Fuel Tank
Group 8 Pump Device
Group 9 Control Valve
Group 10 Pilot Valve
Group 11 Brake Charge Valve
Group 12 Manifold Valve
Group 13 Solenoid Valve
Group 14 Priority Valve
Group 15 Cooling Fan System
Group 16 Ride Control Device
Group 17 Muffler Filter
Group 18 Parallel Link (Special Parts)

All information, illustrations and specifications in this manual are based on the latest product information available at the time of publication. The right is reserved to make changes at any time without notice.

SECTION AND GROUP CONTENTS

WORKSHOP MANUAL

SECTION 4 TRAVEL SYSTEM

Group 1 Tire	
Group 2 HST Motor	
Group 3 Transmission	
Group 4 Axle	
Group 5 Propeller Shaft	
Group 6 Brake Valve	
Group 7 Steering Device	
Group 8 Emergency Steering Device	

SECTION 5 FRONT ATTACHMENT

Group 1 Front Attachment	
Group 2 Cylinder	
Group 3 Front Attachment (Parallel Link)	
Group 4 Cylinder (Parallel Link)	

All information, illustrations and specifications in this manual are based on the latest product information available at the time of publication. The right is reserved to make changes at any time without notice.

TECHNICAL MANUAL (Operational Principle)	TECHNICAL MANUAL (Troubleshooting)
<p>SECTION 1 GENERAL</p> <ul style="list-style-type: none"> Group 1 Specifications Group 2 Component Layout Group 3 Component Specifications <p>SECTION 2 SYSTEM</p> <ul style="list-style-type: none"> Group 1 Controller Group 2 Control System Group 3 ECM System Group 4 Hydraulic System Group 5 Electrical System <p>SECTION 3 COMPONENT OPERATION</p> <ul style="list-style-type: none"> Group 1 Pump Device Group 2 HST Motor Group 3 Control Valve Group 4 Fan Motor and Fan Valve Group 5 Steering Valve Group 6 Priority Valve Group 7 Pilot Valve Group 8 Brake Charge Valve Group 9 Manifold Valve Group 10 Transmission Group 11 Axle Group 12 Brake Valve Group 13 Ride Control Valve Group 14 Others 	<p>SECTION 4 OPERATIONAL PERFORMANCE TEST</p> <ul style="list-style-type: none"> Group 1 Introduction Group 2 Standard Group 3 Engine Test Group 4 Machine Performance Test Group 5 Component Test Group 6 Adjustment <p>SECTION 5 TROUBLESHOOTING</p> <ul style="list-style-type: none"> Group 1 Diagnosing Procedure Group 2 Monitor Group 3 e-Service Group 4 Component Layout Group 5 Troubleshooting A Group 6 Troubleshooting B Group 7 Troubleshooting C Group 8 Air Conditioner

SECTION 1

GENERAL

CONTENTS

Group 1 Precautions for Disassembling and Assembling

Precautions for Disassembling and Assembling	W1-1-1-1
--	----------

Group 2 Tightening

Tightening Bolts and Nuts	W1-2-1-1
Piping Joint	W1-2-1-4

Group 3 Painting

Painting	W1-3-1-1
Painting (Parallel Link)	W1-3-2-1

Group 4 Bleeding Air

Bleeding Air from Hydraulic Oil Tank	W1-4-1-1
Bleeding Air from Hydraulic System	W1-4-1-2
Bleeding Air from Fuel System	W1-4-1-4
Bleeding Air from Radiator	W1-4-1-6
Bleeding Air from Brake (Axle)	W1-4-1-7

Group 5 Releasing Pressure

Front Attachment Hydraulic Circuit Pressure Release Procedure	W1-5-1-1
Ride Control Accumulator Pressure Release Procedure	W1-5-1-2

Group 6 Preparation

Preparation before Inspection and Maintenance	W1-6-1-1
---	----------

(Blank)

SECTION 1 GENERAL

Group 1 Precautions for Disassembling and Assembling

Precautions for Disassembling and Assembling

Precautions for Disassembling

- **Clean the Machine**
Thoroughly wash the machine before bringing it into the shop. Bringing a dirty machine into the shop may cause machine components to be contaminated during disassembling / assembling, resulting in damage to machine components, as well as decreased efficiency in service work.
- **Inspect the Machine**
Be sure to thoroughly understand all disassembling / assembling procedures beforehand to help avoid incorrect disassembling of components as well as personal injury.
Check and record the items listed below to prevent problems from occurring in the future.
 - The machine model, machine serial number, and hour meter reading.
 - Reason for disassembly (symptoms, failed parts, and causes).
 - Clogging of filters and oil, water or air leaks, if any. Capacities and condition of lubricants.
 - Loose or damaged parts.
- **Prepare and Clean Tools and Disassembly Area**
Prepare the necessary tools to be used and the area for disassembling work.

Precautions for Disassembling and Assembling

- **Precautions for Disassembling**
 - Cap the open ends in case the hoses and pipes have been disconnected. In addition, attach an identification tag onto the connectors, hoses, and pipes for assembling.
 - Before disassembling, clean the exterior of the components and place on a workbench.
 - Drain hydraulic oil and gear oil from the hydraulic components and reduction gear.
 - Be sure to provide appropriate containers for draining fluids.
 - Use matching marks for easier reassembling if necessary.
 - Be sure to use the specified special tools when instructed.

- If a part or component cannot be removed after removing its securing nuts and bolts, do not attempt to remove it forcibly. Find the cause (s), then take the appropriate measures to remove it.
 - Orderly arrange disassembled parts. Mark and tag them if necessary.
 - Store common parts, such as bolts and nuts with reference to where they are to be used and in a manner that will prevent loss.
 - Inspect the contact or sliding surfaces of disassembled parts for abnormal wear, sticking, or other damage.
 - Measure and record the degree of wear and clearances.
- **Precautions for Assembling**
 - Be sure to clean all parts and inspect them for any damage. If any damage is found, repair or replace part.
 - Dirt or debris on the contact or sliding surfaces may shorten the service life of the machine. Take care not to contaminate any contact or sliding surfaces.
 - Apply appropriate lubricant oil onto parts in order to prevent them from seizing.
 - Be sure to replace O-rings, backup rings, oil seals, and floating seals with new ones once they have been disassembled. Apply grease before installing
 - Be sure that liquid-gasket-applied surfaces are clean and dry.
 - If an anti-corrosive agent has been used on a new part, be sure to thoroughly clean the part to remove the agent.
 - Fit the matching marks made when disassembling and assemble them.
 - Be sure to use the designated tools to assemble bearings, bushings, and oil seals.
 - Keep a record of the number of tools used for disassembly / assembly. After assembling is completed, count the number of tools so as to make sure that no forgotten tools remain in the assembled machine.

SECTION 1 GENERAL

Group 1 Precautions for Disassembling and Assembling

Precautions for Using Floating Seal

1. In general, replace the floating seal with a new one after disassembling.

If the floating seal is required to be reused, follow these procedures:

- Keep seal rings together as a matched set with seal ring (1) surfaces together. Apply oil onto sliding surface (e) of seal ring (1).
 - Check sliding surface (e) of seal ring (1) for scuffing, scoring, corrosion, deformation, or uneven wear. Check the step part of seal ring (1).
 - Check O-ring (2) for tears, breaks, deformation, or hardening.
2. If incorrectly assembled, oil leakage or damage will occur. Be sure to do the following to prevent trouble.
 - Clean the floating seal and seal mounting bores with cleaning solvent. Use a wire brush to remove mud, rust, or dirt from seal mounting bores. After cleaning, thoroughly dry parts with compressed air.
 - Clean seal ring (1) and O-ring (2) mounting bores. Check the bore surface for scuffing or scoring by touching the surface with finger.
 - After installing the floating seal, check that O-ring (2) is not twisted, and that it is installed correctly on seal ring (1).
 - After installing the floating seal, check that O-ring (2) and seal ring sliding surface (e) is parallel with seal mating surface (f) by measuring the distances (e) and (f) at point (A) and (B), as illustrated. If these distances differ, correct O-ring (2) seating.

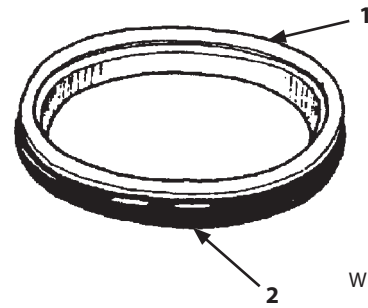

W178-02-11-001

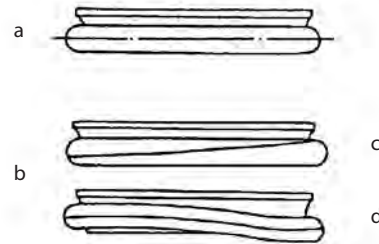
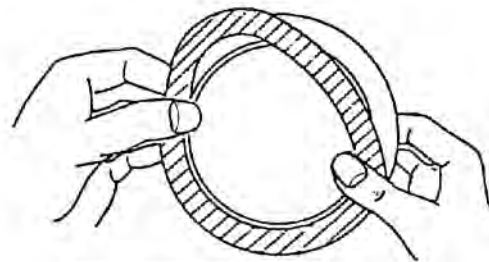

W178-02-11-002

- a - Correct
 b - Incorrect
 c - Twist of O-Ring
 d - Bend of O-Ring

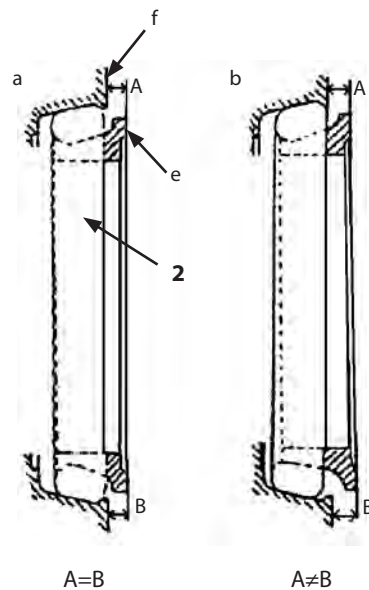

W178-02-11-003

- a - Correct
 b - Incorrect
 e - Sliding Surface
 f - Seal Mating Surface

SECTION 1 GENERAL

Group 1 Precautions for Disassembling and Assembling

Precautions for Using Nylon Sling

1. Follow the precautions below to use nylon slings safely.
 - Attach protectors (soft material) on the corners of the load so that the nylon sling does not directly contact the corners. This will prevent the nylon sling from being damaged and the lifted load from slipping.
 - Lower the temperature of the lifted load to lower than 100 °C (212 °F). If unavoidably lifting a load with a temperature of 100 °C (212 °F) or more, reduce the load weight.
 - Do not lift acid or alkali chemicals.
 - Take care not to allow the sling to become wet. The load may slip.
 - When required to use more than one sling, use slings with the same width and length to keep the lifted load balanced.
 - When lifting a load using an eyehole, be sure to eliminate any gaps between the sling and load. (Refer to the right illustration.) Reduce the load weight so that it is less than 80 % of the sling breaking force.
 - Avoid using twisted, bound, connected, or hitched slings.
 - Do not place any object on twisted or bent slings. (Refer to the right illustration.)
 - When removing the slings from under the load, take care not to damage the nylon slings. Avoid contact with protrusions.
 - Avoid dragging slings on the ground, throwing slings, or pushing slings with a metal object.
 - When using with other types of slings (wire rope) or accessories (shackle), protect the joint so that the nylon sling is not damaged.
 - Store the nylon slings indoors so that they won't deteriorate with heat, sun light, or chemicals.

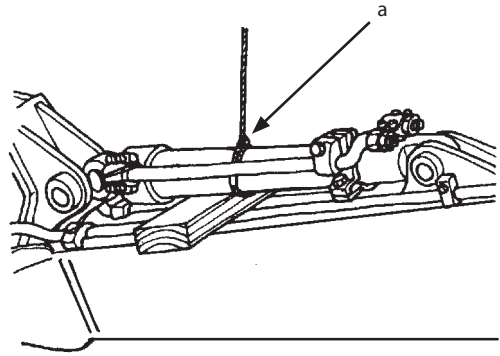

W102-04-02-016

a - Correct Eyehole Lifting Method

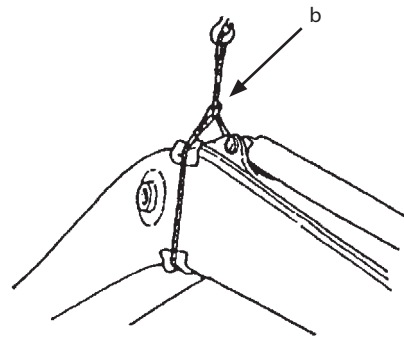

W105-04-01-008

b - Incorrect Eyehole Lifting Method

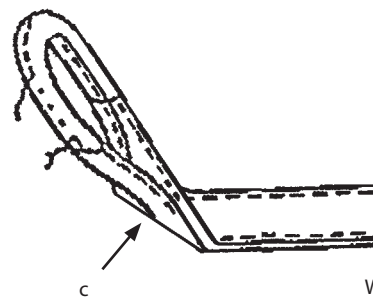

W162-01-01-009

c - Bent of Sling

SECTION 1 GENERAL

Group 1 Precautions for Disassembling and Assembling

⚠ CAUTION: If a load is lifted with a damaged nylon sling, serious personal injury may result. Be sure to visually check the nylon sling for any damage before using.

2. Before using a nylon sling, visually check the nylon sling for any damage corresponding to examples shown to the right. If any damage is found, cut and discard the sling. Even if no damage is found, do not use slings older than 7 years.

Damaged Appearance

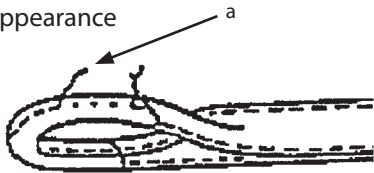

W162-01-01-002

a - Broken Sewing Thread

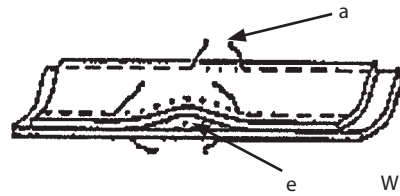

W162-01-01-006

a - Broken Sewing Thread e - Separation of Belt

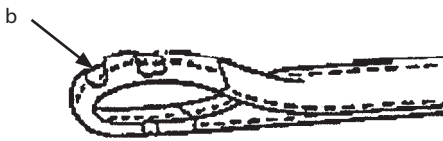

W162-01-01-003

b - Scuffing

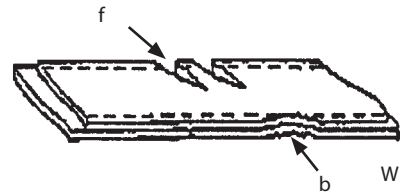

W162-01-01-007

b - Scuffing f - Scoring

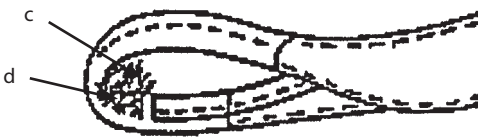

W162-01-01-004

c - Fuzz d - Broken Sewing Thread

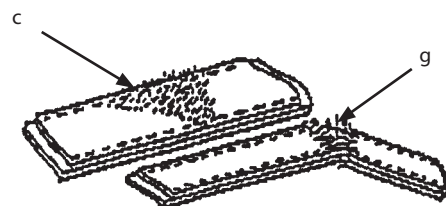

W162-01-01-008

c - Fuzz g - Broken Warp



W162-01-01-005

a - Broken Sewing Thread

SECTION 1 GENERAL

Group 1 Precautions for Disassembling and Assembling

Maintenance Standard Terminology

"Standard"

1. Dimension for parts on a new machine.
2. Dimension of new components or assemblies adjusted to specification. Allowable errors will be indicated if necessary.

"Allowable Limit"

1. Normal machine performance cannot be accomplished after exceeding this limit.
2. Repair or adjustment is difficult after exceeding this limit.
3. Repair or adjustment is impossible after exceeding this limit.
Therefore, in consideration of operation efficiency and maintenance expense, proper maintenance shall be carried out before reaching the "Allowable Limit".

SECTION 1 GENERAL
Group 1 Precautions for Disassembling and Assembling

(Blank)

SECTION 1 GENERAL

Group 2 Tightening

Tightening Bolts and Nuts

CAUTION: Use tools appropriate for the work to be done. Makeshift tools and procedures can create safety hazards. For loosening and tightening nuts and bolts, use correct size tools. Otherwise, tightening tools may slip, potentially causing personal injury.



IMPORTANT:

- Apply lubricant to the bolts and nuts in order to reduce friction coefficient of them. (For example, spindle oil with white zinc B dissolved in it)
- Clean the bolt and nut threads and remove dirt or corrosion before installing.

WDAA-01-02-001

Bolt Types

Tighten the nuts or bolts correctly to the torque specifications.
As the different types and grades of bolt are used, use and tighten the correct bolts correctly when assembling the machine or components.

Specified Tightening Torque Chart

2013/09

Bolt Dia. mm	Hexagon Head Bolt						Socket Bolt			
	 WDAA-01-02-002		 WDAA-01-02-003		 WDAA-01-02-004		Wrench Size mm	Socket Bolt		Wrench Size mm
	N·m	(lbf·ft)	N·m	(lbf·ft)	N·m	(lbf·ft)		N·m	(lbf·ft)	
6					3 to 4	(2.2 to 3)	10			5
8	30	(22)	20	(15)	10	(7.4)	13	20	(15)	6
10	65	(48)	50	(37)	20	(15)	17	50	(37)	8
12	110	(81)	90	(66)	35	(26)	19	90	(66)	10
14	180	(133)	140	(103)	55	(41)	22	140	(103)	12
16	270	(200)	210	(155)	80	(59)	24	210	(155)	14
18	400	(300)	300	(220)	120	(89)	27	300	(220)	14
20	550	(410)	400	(300)	170	(125)	30	400	(300)	17
22	750	(550)	550	(410)	220	(162)	32			
24	950	(700)	700	(520)	280	(205)	36			
27	1400	(1030)	1050	(770)	400	(300)	41			
30	1950	(1440)	1450	(1070)	550	(410)	46			
33	2600	(1920)	1950	(1440)	750	(550)	50			
36	3200	(2360)	2450	(1810)	950	(700)	55			

SECTION 1 GENERAL

Group 2 Tightening

IMPORTANT: The following items are applied to both fine and coarse pitch threads.

- Apply lubricant to the bolts and nuts in order to reduce friction coefficient of them. (For example, spindle oil with white zinc B dissolved in it)
- Torque tolerance is $\pm 10\%$.
- Use the bolts of correct length. The bolts that are too long cannot be tightened as the bolt tip comes into contact with the bottom of bolt hole. Also the bolts that are too short cannot develop sufficient tightening force.
- The torque given in the chart on the previous page are for general use only, however, a different torque is given for a specific application. Use the specified torque.
- Clean the nut and bolt threads and remove dirt or corrosion before installing.

Tightening Order

When tightening two or more bolts, tighten them alternately, as shown, to ensure even tightening.

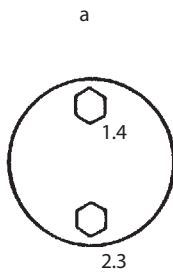

a - Equally tighten upper and lower alternately

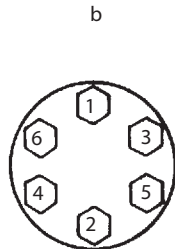

b - Tighten diagonally

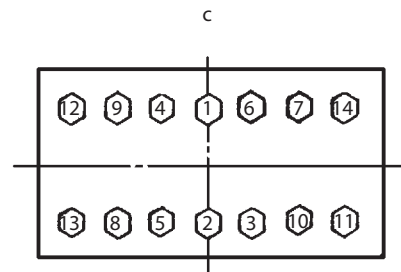

c - Tighten from center diagonally

W105-01-01-003

Thanks for your reading.

Please click here to download complete manual instantly.

And can also choose other manuals.

Feel free --->write to me with any questions.

Our service email:

manuals007@hotmail.com