

821G
921G
Tier 4B (final)
Wheel Loader

SERVICE MANUAL

Part number 48083737

1st edition English
December 2016





SERVICE MANUAL

**821G WHEEL LOADER XR-EH, NEW CAB TIER4B NA
821G WHEEL LOADER ZBAR-EH, NEW CAB TIER4B NA
921G WHEEL LOADER XR-EH, NEW CAB TIER4B NA
921G WHEEL LOADER ZBAR-EH, NEW CAB TIER4B NA**

Link Product / Engine

Product	Market Product	Engine
821G WHEEL LOADER ZBAR-EH, NEW CAB TIER4B NA	North America	F4HFE613S*B003
821G WHEEL LOADER XR-EH, NEW CAB TIER4B NA	North America	F4HFE613S*B003
921G WHEEL LOADER ZBAR-EH, NEW CAB TIER4B NA	North America	F4HFE613R*B005
921G WHEEL LOADER XR-EH, NEW CAB TIER4B NA	North America	F4HFE613R*B005

Contents

INTRODUCTION

Engine	10
[10.001] Engine and crankcase	10.1
[10.202] Air cleaners and lines	10.2
[10.500] Selective Catalytic Reduction (SCR) exhaust treatment	10.3
[10.400] Engine cooling system	10.4
[10.414] Fan and drive	10.5
[10.310] Aftercooler.....	10.6
[10.304] Engine lubrication system.....	10.7
Transmission	21
[21.113] Powershift transmission	21.1
[21.155] Powershift transmission internal components.....	21.2
[21.700] Torque converter	21.3
Four-Wheel Drive (4WD) system	23
[23.314] Drive shaft.....	23.1
Front axle system	25
[25.100] Powered front axle	25.1
[25.102] Front bevel gear set and differential	25.2
[25.108] Final drive hub, steering knuckles, and shafts	25.3
Rear axle system	27
[27.100] Powered rear axle.....	27.1
[27.106] Rear bevel gear set and differential	27.2
[27.120] Planetary and final drives	27.3
Brakes and controls	33
[33.202] Hydraulic service brakes	33.1
[33.110] Parking brake or parking lock	33.2

Hydraulic systems	35
[35.000] Hydraulic systems.....	35.1
[35.300] Reservoir, cooler, and filters.....	35.2
[35.106] Variable displacement pump	35.3
[35.359] Main control valve.....	35.4
[35.357] Pilot system	35.5
[35.752] Hydraulic fan drive cooling system.....	35.6
[35.701] Front loader arm hydraulic system	35.7
[35.723] Front loader bucket hydraulic system	35.8
[35.734] Tool quick coupler hydraulic system	35.9
Frames and ballasting	39
[39.100] Frame	39.1
Steering	41
[41.101] Steering control	41.1
[41.200] Hydraulic control components.....	41.2
[41.216] Cylinders	41.3
[41.910] Auxiliary steering.....	41.4
Wheels	44
[44.511] Front wheels.....	44.1
[44.520] Rear wheels.....	44.2
Cab climate control	50
[50.200] Air conditioning.....	50.1
Electrical systems	55
[55.100] Harnesses and connectors.....	55.1
[55.301] Alternator.....	55.2
[55.302] Battery.....	55.3
[55.988] Selective Catalytic Reduction (SCR) electrical system	55.4

[55.989] Exhaust Gas Recirculation (EGR) electrical system	55.5
[55.512] Cab controls	55.6
[55.530] Camera	55.7
[55.DTC] FAULT CODES	55.8
Front loader and bucket	82
[82.100] Arm	82.1
[82.300] Bucket	82.2
Platform, cab, bodywork, and decals	90
[90.150] Cab	90.1
[90.105] Machine shields and guards	90.2



INTRODUCTION

Contents

INTRODUCTION

Safety rules	3
Personal safety	4
Basic instructions - Important notice regarding equipment servicing	13
Basic instructions - How to use the maintenance standard and precautions	14
Basic instructions - Precaution for disassembly and assembly	16
Basic instructions - Electrical equipment precautions	18
Consumables	19
Consumables - Biodiesel Fuel	21
Hydraulic contamination	22
Product identification	23
Product identification	24

Safety rules

Personal safety

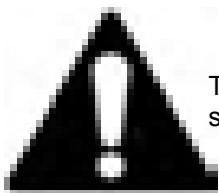



This is the safety alert symbol. It is used to alert you to potential personal injury hazards. Obey all safety messages that follow this symbol to avoid possible death or injury.

Throughout this manual you will find the signal words DANGER, WARNING, and CAUTION followed by special instructions. These precautions are intended for the personal safety of you and those working with you.

Read and understand all the safety messages in this manual before you operate or service the machine.

 DANGER indicates a hazardous situation that, if not avoided, will result in death or serious injury.

 WARNING indicates a hazardous situation that, if not avoided, could result in death or serious injury.

 CAUTION indicates a hazardous situation that, if not avoided, could result in minor or moderate injury.

FAILURE TO FOLLOW DANGER, WARNING, AND CAUTION MESSAGES COULD RESULT IN DEATH OR SERIOUS INJURY.

Machine safety

NOTICE: Notice indicates a situation that, if not avoided, could result in machine or property damage.

Throughout this manual you will find the signal word Notice followed by special instructions to prevent machine or property damage. The word Notice is used to address practices not related to personal safety.

Information

NOTE: Note indicates additional information that clarifies steps, procedures, or other information in this manual.

Throughout this manual you will find the word Note followed by additional information about a step, procedure, or other information in the manual. The word Note is not intended to address personal safety or property damage.

Personal safety

Carefully read this Manual before proceeding with maintenance, repairs, refuelling or other machine operations.

Repairs have to be carried out only by authorized and instructed staff; specific precautions have to be taken when grinding, welding or when using mallets or heavy hammers.

Non-authorized persons are not allowed to repair or carry out maintenance on this machine. Do not carry out any work on the equipment without prior authorization.

Ask your employer about the safety instructions in force and safety equipment.

Nobody should be allowed in the cab during machine maintenance unless he is a qualified operator helping with the maintenance work.

If it is necessary to move the equipment to carry out repairs or maintenance, do not lift or lower the equipment from any other position than the operator's seat.

Never carry out any operation on the machine when the engine is running, except when specifically indicated.

Stop the engine and ensure that all pressure is relieved from hydraulic circuits before removing caps, covers, valves, etc.

All repair and maintenance operations should be carried out with the greatest care and attention.

Service stairs and platforms used in a workshop or in the field should be built in compliance with the safety rules in force.

Any functional disorders, especially those affecting the safety of the machine, should therefore be rectified immediately.

⚠ DANGER

Unexpected movement!

Make sure parking brake is applied. Secure machine with wheel chocks.

Failure to comply will result in death or serious injury.

D0013A

Before performing any work on the machine, attach a maintenance in progress tag. This tag can be applied on the left-hand control lever, safety lever or cab door.

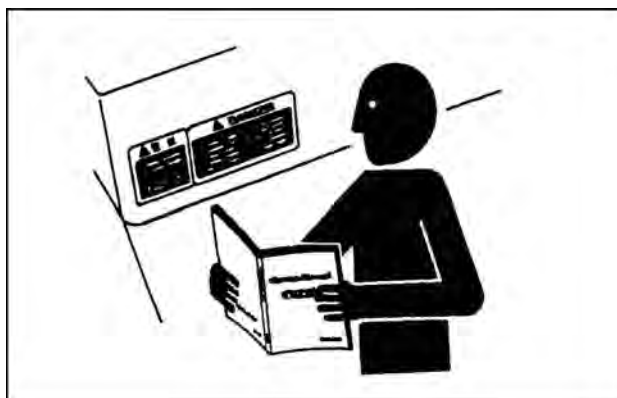

TULI12WEX2004AA 1



TULI12WEX2005AA 2

Emergency

Be prepared for emergencies. Always keep a fire extinguisher and first aid kit readily available. Ensure that the fire extinguisher is serviced in accordance with the manufacturer's instructions.



SML12WEX0174AA 3

Equipment

Wear close fitting clothing and safety equipment appropriate for the job:

- Safety helmet
- Safety shoes
- Heavy gloves
- Reflective clothing
- Wet weather clothing

If working conditions require, the following personal safety equipment should be on hand:

- Respirators (or dust proof masks)
- Ear plugs or acoustic ears protections
- Goggles with lateral shield or masks for eye protection

Do not wear rings, wristwatches, jewelry, unbuttoned or flapping clothing such as ties, torn clothes, scarves, open jackets or shirts with open zips which could get caught into moving parts.



TUL12WEX2008AA 4

Engine - Radiator

Never leave the engine running in enclosed spaces without proper ventilation which is able to evacuate toxic exhaust gases- Keep the exhaust manifold and tube free from combustible materials.

Do not refuel with the engine running, especially if hot, as this increases fire hazard in case of fuel spillage.

Never attempt to check or adjust the belts when the engine is running.

Never lubricate the machine with the engine running.

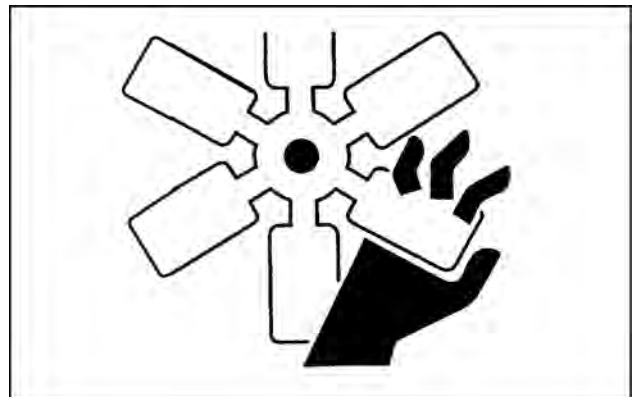

TUL12WEX2009AA 5

Pay attention to rotating components and do not allow anyone to approach these areas to avoid becoming entangled.

Hands, clothing or tools getting caught in the fan blades or engine belts, can cause amputations, violent hemorrhages and generate conditions of grave danger. For this reason avoid touching or approaching all rotating or moving parts.

A surging spray of the coolant from the radiator can cause serious burns and scalds.

Before checking the coolant level, shut-off the engine and allow machine to cool down the radiator and hoses. Slowly unscrew the cap to release any residual pressure.

If it is necessary to remove the cap while engine is hot, wear safety clothes and equipment, then loosen the cap slowly to relieve the pressure gradually.

When checking the fuel, oil and coolant levels, use lights and lamps explicitly designated as explosion proof. If these types of lamps are not used, fires or explosions may occur.

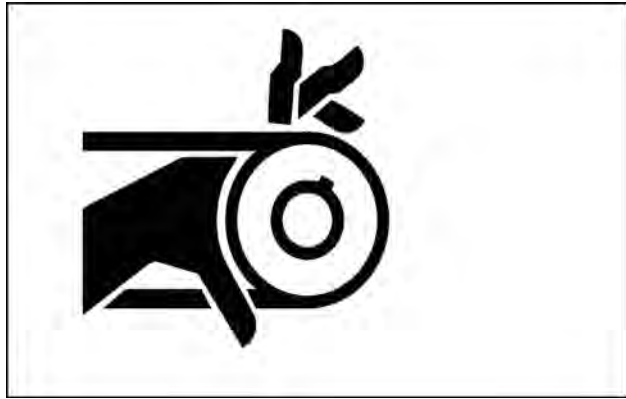

TULI12WEX2010AA 6



TULI12WEX2011AA 7

Hydraulic systems

Jets of fluids under pressure can penetrate the skin causing serious injuries.

Avoid this hazard by relieving pressure before disconnecting hydraulic or other lines.

Relieve the residual pressure by moving the hydraulic control levers several times.

Tighten all connections before applying pressure.

To protect the eyes wear a facial shield or safety goggles.

Protect your hands and body from possible jets of fluids under pressure.

Swallowing hydraulic oil is a severe health hazard.



TULI12WEX2012AA 8

INTRODUCTION

When hydraulic oil has been swallowed, avoid vomiting, but consult a doctor or go to a hospital.

If an accident occurs, see a doctor familiar with this type of injury immediately.

Any fluid penetrating the skin must be removed within a few hours to avoid serious infections.

Flammable splashes may originate because of heating near lines with fluids under pressure, resulting in serious burns. Do not weld or use torches near lines containing fluids or other flammable materials.

Lines under pressure can accidentally be pierced when the heat expands beyond the area immediately heated.

Arrange for temporary fire resistant shields to protect hoses or other components during welding or torch use.

Have any visible leakage repaired immediately.

Discharged oil pollutes the environment. Soak up any oil that has spilled with a proper binding agent. Sweep up binding agent and dispose of it separately from other waste.

Never search for leakages with fingers; instead, use a piece of cardboard and always wear goggles.

Never repair a damaged line; always replace it. Replace hydraulic hoses immediately on detecting any damaged or moist areas.

Always store hydraulic oil in the original containers.

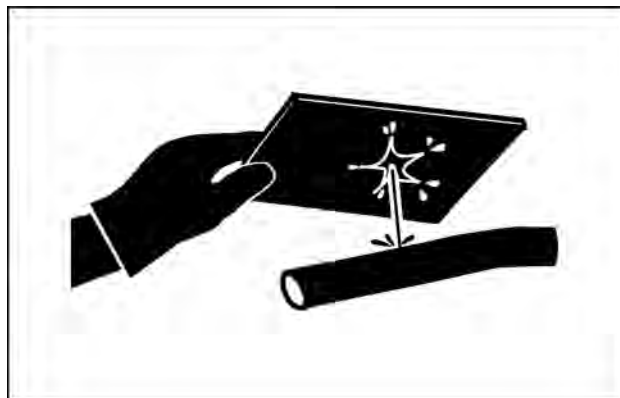

TULI12WEX2013AA 9

Hoses and tubes

Always replace hoses and tubes if the cone end or the end connections on the hose are damaged.

When installing a new hose, loosely connect each end and make sure the hose takes up the correct position before tightening the connections. Clamps should be tightened sufficiently to hold the hose without crushing and to prevent chafing.

After replacing a hose on a moving component, check that the hose does not fall by moving the component through the complete range of travel. Be sure any hose which has been installed is not kinked or twisted.

Hose connections which are damaged, dented, crushed or leaking, restrict oil flow and the productivity of the components being served. Connectors which show signs of movement from the original position have failed and will ultimately separate completely.

A hose with a frayed outer sheath will allow water penetration. Concealed corrosion of the wire reinforcement could subsequently occur along the hose length with resultant hose failure.

Ballooning of the hose indicates an internal leakage due to structural failure. This condition rapidly deteriorates and total hose failure soon occurs.

Kinked, crushed, stretched or deformed hoses generally suffer internal structural damage which can result in oil restriction, a reduction in the speed of operation and ultimate hose failure.

Free-moving, unsupported hoses must never be allowed to touch each other or related working surfaces. This causes chafing which reduces hose life.

O-rings

Replace O-rings, seal rings and gaskets whenever they are disassembled.

Never mix new and old seals or O-rings, regardless of condition. Always lubricate new seal rings and O-rings with hydraulic oil before installation to relevant seats.

This will prevent the O-rings from rolling over and twisting during mounting which will jeopardize sealing.

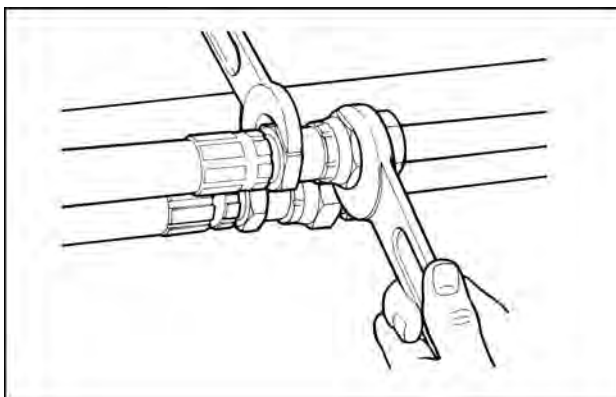

TUL112WEX2014AA 10

Battery

Batteries give off explosive gases.

Never handle open flames and unshielded light sources near batteries. (No smoking is addressed in the next instruction).

To prevent any risk of explosion, observe the following instructions:

- When disconnecting the battery cables, always disconnect the negative (-) cable first.
- To reconnect the battery cables, always connect the negative (-) cable last.
- Never short-circuit the battery terminals with metal objects.
- Do not weld, grind or smoke near a battery.

Battery electrolyte causes severe burns. The battery contains sulphuric acid. Avoid any contact with the skin, eyes or clothing.

Treatment:

- EXTERNAL: Rinse well with water, removing any soiled clothing.
- INTERNAL: Avoid vomiting. Drink water to rinse your mouth. Consult a doctor.
- EYES: Rinse abundantly with water for **15 min** and consult a doctor.
- When the electrolyte of a battery is frozen, it can explode if you attempt to charge the battery or if you try to start the engine using a booster battery. Always keep the battery charged to prevent the electrolyte freezing.

Provide good ventilation when changing a battery or using a battery in an enclosed space. Always protect your eyes when working near a battery.

Never set tools down on the battery. They may induce a short circuit, causing irreparable damage to the battery and injuring persons.

Never wear metal necklaces, bracelets or watch straps when working on the battery. The metal parts may induce a short circuit resulting in burns.

Dispose of used batteries separately from other waste in the interests of environmental protection.

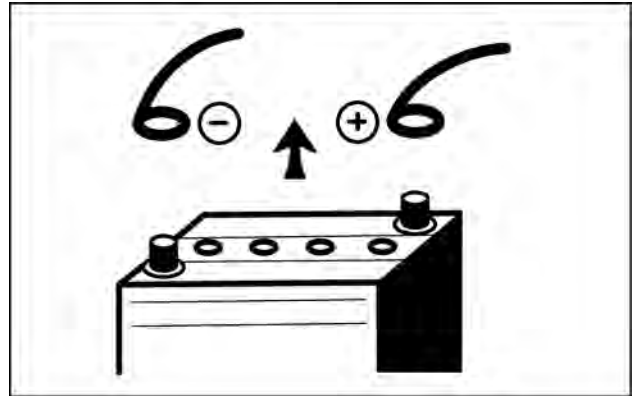

TUL112WEX2015AA 11



TUL112WEX2016AA 12



TUL112WEX2017AA 13

Flammable liquids

When handling flammable liquids:

- Do not smoke.
- Keep away from unshielded light sources and open flames.

Fuels often have a low flash point and are readily ignited.

Never attempt to extinguish burning liquids with water. Use:

- Dry powder
- Carbon dioxide
- Foam

Water used for extinguishing purposes would vaporize instantaneously on contact with burning substances and spread burning oil, for example, over a wide area. Water generates short circuits in the electrical system, possibly producing new hazards.

Stay away from open flames during refilling of hydraulic oil or fuel.

Fuel or oil spills can cause slipping hazards; thoroughly contain and clean affected areas.

Always tighten the safety plugs of fuel tank and hydraulic oil tank firmly.

Never use fuel to clean machine parts that will be exposed to dirt or debris.

Use a non-flammable product for cleaning parts.

Always perform fuel or oil refilling in well aired and ventilated areas.

During refuelling hold the pistol firmly and always keep it in contact with the filler neck until the end of the refuelling, to avoid arcing due to static electricity.

Do not overfill the tank but leave a space for fuel expansion.

Never refuel when the engine is running.

Take all the necessary safety measures when welding, grinding or when working near an exposed flame.



TUL112WEX2016AA 14



TUL112WEX2018AA 15



TUL112WEX2019AA 16

Tires

Before inflating the tires, always check the condition of rims and the outer condition of tires for the presence of dents, cuts, tears of reinforcement plies or other faults. Before inflating a tire, make sure that there are no nearby persons, then position yourself at tread side.

When inflating tires, ensure tire pressure does not exceed that prescribed by the tire manufacturer. Ensure that the pressure of the right tire corresponds to the pressure of the left tire.

NOTE: *The front and rear tire pressures may be different.*

Never use reconditioned rims because possible welds, heat treatments or brazings not performed correctly can weaken the wheels and cause damage or failure. Deflate the tires before their disassembly.

Before taking out possible jammed objects from the rims, it is necessary to deflate the tires. Inflate tires by means of an inflation pistol complete with extension and pressure control valve.

Use an inflation cage.

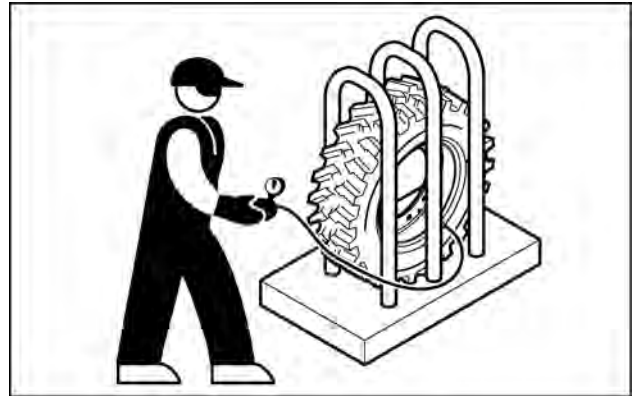

TUL112WEX2020AA 17

Cleaning

Clean the exterior of all components before carrying out any form of repair. Dirt and dust can reduce the efficient working life of a component and lead to costly replacement.

Solvents should be checked that they are suitable for the cleaning of components and also that they do not risk the personal safety of the user.

Dirt, oil, grease and scattered tools are dangerous for people, because they can create slipping or tripping hazards.

For machine cleaning, use a jet of warm water or steam under pressure and commercial detergents. Never use fuel, petroleum or solvents, because they can leave an oily residue that attracts dust, and solvents (even if weak) damage the paint and can lead to the formation of rust.

Never use water jets or steam on sensors, connectors or other electric components.

Avoid direct spray of seals and seams to prevent water penetration inside the cab.

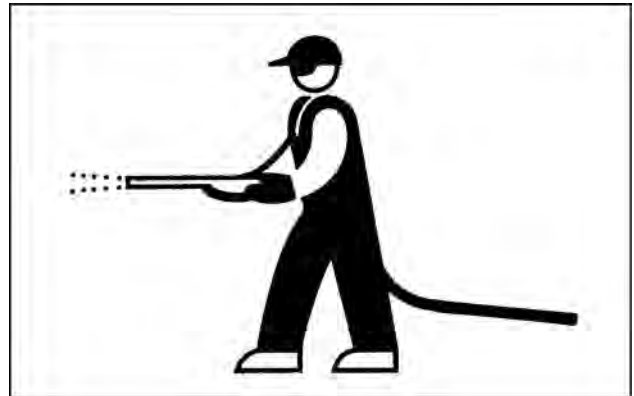

TUL112WEX2021AA 18

Waste disposal

Improperly disposing of waste can threaten the environment.

Each country has its own Regulations on this subject. It is therefore advisable to prepare suitable containers to collect and store momentarily all solid and fluid materials that must not be scattered in the environment to avoid pollution.

These products will be delivered at preset intervals following the forward environmental regulation.

Below are listed some products from the machine requiring disposal:

- Lubricating oil
- Brake system oil
- Coolant mixture, condensation rests and pure antifreeze
- Fuel
- Filter elements, oil and fuel filters
- Filter elements, air filters
- Battery

Also polluted rags, paper, sawdust and gloves must be disposed in compliance with the same procedures.

Do not use food or beverage containers that may mislead someone into drinking from them. Do not pour waste onto the ground, down a drain, or into any water source. Air conditioning refrigerants escaping into the air can damage the Earth's atmosphere. Government regulations may require a certified air conditioning service centre to recover and recycle used air conditioning refrigerants. Obtain information on the proper way to recycle or dispose of waste from your local environmental or recycling centre, or from your Dealer.

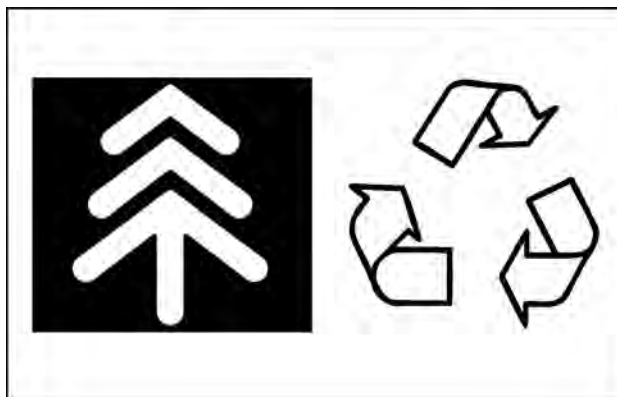

TUL112WEX2022AA 19

Basic instructions - Important notice regarding equipment servicing

All repair and maintenance work listed in this manual must be carried out only by qualified dealership personnel, strictly complying with the instructions given, and using, whenever possible, the special tools.

Anyone who performs repair and maintenance operations without complying with the procedures provided herein shall be responsible for any subsequent damages.

The manufacturer and all the organizations of its distribution chain, including - without limitation - national, regional, or local dealers, reject any responsibility for damages caused by parts and/or components not approved by the manufacturer, including those used for the servicing or repair of the product manufactured or marketed by the manufacturer. In any case, no warranty is given or attributed on the product manufactured or marketed by the manufacturer in case of damages caused by parts and/or components not approved by the manufacturer.

The information in this manual is up-to-date at the date of the publication. It is the policy of the manufacturer for continuous improvement. Some information could not be updated due to modifications of a technical or commercial type, or changes to the laws and regulations of different countries.

In case of questions, refer to your CASE CONSTRUCTION Sales and Service Networks.

Basic instructions - How to use the maintenance standard and precautions

Application

WHEN THE MACHINE IS NEW

Confirm that the performances are in accordance with standard specifications as compared to the performance standards.

AT SPECIFIC SELF INSPECTION (RULE BY COUNTRY)

Use the data for the criterion, for the purpose of correction, adjustment and replacement.

WHEN PERFORMANCES ARE DETERIORATED

Determine whether it is caused by a fault or end of service life after long hours of operation, to be used for safety and economical considerations.

WHEN MAIN COMPONENTS ARE REPLACED

For example, use data to restore performances of pumps and others.

Terminology

STANDARD VALUES

Values to be used to condition or assemble a new machine. Where special notes are not given, these values represent standard specifications (machine with standard attachments and standard tires).

REFERENCE VALUES FOR REMEDY

Values at which readjustment is required. In order to ensure performance and safety it is strictly prohibited to use the machine over the specified values.

SERVICE LIMIT

This is the limit value at which reconditioning is impossible without replacement of parts. If the value is expected to exceed the service limit before next inspection and correction are performed, replace the parts immediately. The operation over the specified values causes increase of damage and requires the down time of machine, and also causes safety problems.

Cautions to be exercised at judgment

EVALUATION OF MEASURED DATA

Disagreement of measuring conditions, variations of data peculiar to a new machine, and measuring errors are to be evaluated. Determine generally at what levels measured values are located, instead of determining whether or not values fall within or run out of the reference values.

DETERMINING CORRECTION, ADJUSTMENT OR REPLACEMENT

Machine performances deteriorate with time as parts wear and some deteriorated performances may be restored to new levels. Therefore, determine correction, adjustment or replacement, depending upon the operating hours, kind of work and circumstances in which the machine is placed, and condition the machine performances to its most desirable levels.

Other cautions to be exercised

PARTS LIABLE TO DEGRADE

Rubber products, such as, hydraulic hoses, O-rings, and oil seals deteriorate with time; replace them at regular intervals or at overhauls.

PARTS REQUIRING REGULAR REPLACEMENT

Critical hoses that are necessary to secure safety, we designate as Very Important Parts (V.I.P.) and recommend that they should be replaced regularly.

INSPECTION AND REPLACEMENT OF OILS AND GREASES

In performing maintenance, it is necessary for the user to familiarize themselves with the machine and handle safely. Use caution when inspecting and replacing oils and grease. Refer to the Operators Manuals as well.

Basic instructions - Precaution for disassembly and assembly

Preparations for disassembly

- Thoroughly wash the machine before bringing it into the shop. Bringing a dirty machine into the shop may cause machine components to be contaminated during disassembling/assembling, resulting in damage to machine components, as well as decreased efficiency in service work.
- Be sure to thoroughly understand all disassembling/assembling procedures beforehand, to help avoid incorrect disassembling of components as well as personal injury.
- Check and record the items listed below to prevent problems from occurring in the future.
 1. The machine model, machine serial number, and hour meter reading.
 2. Reason for disassembly (symptoms, failed parts, and causes).
 3. Clogging of filters and oil, water or air leaks, if any.
 4. Capacities and condition of lubricants.
 5. Loose or damaged parts.
- Prepare the necessary tools to be used and the area for disassembling work.
- Wear appropriate clothing, safety shoes, safety helmet, goggles, and clothes with long sleeves.
- Confirm ready access to a first-aid kit and fire extinguisher, as well as appropriate emergency personnel contacts in the case of a medical accident or fire.
- Before performing any work on the machine, follow lockout/tagout procedures by attaching a “maintenance in progress tag”. This tag can be applied on the left-hand control lever, safety lever or cab door. Notify those with access to the machine that you will be performing the maintenance.

Disassembling and assembling hydraulic equipment

- Before removing lines, release the pressure of hydraulic oil tank, or open the cover on the return side to tank, and take out the filter.
- Drain the oil in removed lines into an appropriate container to prevent oil contamination.
- Protect open connections with plugs or caps to prevent oil from leaking and debris from contaminating the system.
- Thoroughly clean the outside of components before disassembling, and drain hydraulic oil and gear oil before disassembly.

Disassembling hydraulic equipment

- Impaired performance and function of hydraulic equipment after unauthorized service may not be covered under warranty by the manufacturer. Consult your local dealer for service.
- If it is unavoidably necessary to disassemble and modify, it should be carried out by experts or personnel qualified through service training.
- Make match mark on parts for reassembling.
- Before disassembling, read instructions in advance, and determine if the service is required to be performed by an authorized dealer.
- Use appropriate specialty tools and jigs if required.
- If parts can not be removed as specified by the procedure, never force removal. Check for other failures that may be causing binding or interference.
- Inspect parts for wear and clearance; record the measured values. Replace components if the values fall outside of the recommended range.
- If an abnormality is detected, repair or replace the parts.
- When removing parts, use appropriate markings or labels to ensure they can be reinstalled in the correct order and location without confusion.
- For common parts, pay attention to the quantity and locations of each group of components.

Reassembling hydraulic equipment

- Clean parts in a well ventilated room.
- Remove residual oil with compressed air, and apply fresh hydraulic oil or gear oil to surfaces before reassembly.
- Replace removed o-rings, back-up rings and oil seals with new ones. Apply gear oil on them before reassembling.
- Thoroughly clean and dry surfaces on which liquid sealant must be reapplied.
- Before assembling, remove rust preventives on new parts.
- Use special tools to fit bearings, bushing and oil seal.
- Assemble parts matching to the marks.
- After completion, check that there is no omission of parts.

Basic instructions - Electrical equipment precautions

⚠ WARNING

Battery acid causes burns. Batteries contain sulfuric acid.

Avoid contact with skin, eyes or clothing. Antidote (external): Flush with water. Antidote (eyes): flush with water for 15 minutes and seek medical attention immediately. Antidote (internal): Drink large quantities of water or milk. Do not induce vomiting. Seek medical attention immediately.

Failure to comply could result in death or serious injury.

W0111A

- The disassembly of electrical equipment is not allowed.
- Handle equipment with care so as not to drop it or bump it.
- Connector should be removed by unlocking while holding the connector.
- Never disconnect electrical plugs by pulling on the wires. Always use only the electrical connectors to make the disconnection.
- Check that connector is connected and locked completely.
- Engine key off before removing and connecting connector.
- Engine key off before touching terminals of starter and alternator.
- Wash machine with care so as not to splash water on electrical equipment and connector.
- If water has entered a sealed connection, thoroughly dry both connectors before reconnecting
- Remove battery grounding terminal before beginning work close to battery and battery relay with tools.

Consumables

821G Capacities and specifications

Engine		
Type of oil		CASE AKCELA UNITEK NO. 1™ SBL CJ-4
Technical specifications		SAE 10W-40 API CJ-4
CASE CONSTRUCTION specifications		MAT3521
Type of oil		CASE AKCELA UNITEK NO. 1™ SSL CJ-4 SAE 0W-40 (cold weather)
Technical specifications		SAE 0W-40 API CJ-4
CASE CONSTRUCTION specifications		MAT3521
Capacity (with filter change)		13.25 l (14.0 US qt)
Total capacity in system		15.1 l (16 US qt)
Cooling system		
Type of coolant		CASE AKCELA ACTIFULL™ OT EXTENDED LIFE COOLANT
CASE CONSTRUCTION specifications		MAT3624
System capacity		30.0 l (32.0 US qt)
Fuel system		
System capacity		288.0 l (76.0 US gal)
Hydraulic system		
Type of fluid		CASE AKCELA HY-TRAN® ULTRACTION
Technical specifications		ISO VG-46
CASE CONSTRUCTION specifications		MAT 3540
Type of fluid		CASE AKCELA HY-TRAN® ULTRACTION SSL (low temperature)
CASE CONSTRUCTION specifications		MAT 3541
Total system capacity		178.0 l (47.0 US gal)
Reservoir capacity		90.8 l (24.0 US gal)
Transmission		
Type of oil		CASE AKCELA NEXPLORE™ FLUID
Technical specifications		SAE 10W - 30 API GL-4 ISO VG-32/46
CASE CONSTRUCTION specifications		MAT 3525
Service capacity - with filter change		34.1 l (36.0 US qt)
Axles		
Type of oil		CASE AKCELA TRANSAXLE FLUID 80W-140
Technical specifications		SAE 80W-140 API GL-4
CASE CONSTRUCTION specifications		MAT 3510
Front axle (Standard and Heavy Duty)		40.0 l (42.3 US qt)
Rear axle (Standard and Heavy Duty)		40.0 l (42.3 US qt)
DEF/AdBLUE®		
Technical specifications		ISO 22241-1
CASE CONSTRUCTION specifications		ES-BS001
Total capacity (*)		37.1 L (39.2 US qt)
Grease fittings, as required		
CASE CONSTRUCTION specifications		MAT3550 Grade C

NOTICE: (*) some liters always remains in the DEF/AdBLUE® reservoir. This allows for correct functioning of the wheel loader components. DO NOT overfill the DEF/AdBLUE® tank. The tank is full when the DEF/AdBLUE® fluid level in the tank reaches the bottom of the fill neck. Adequate air volume must be present in the top of the tank for proper functionality of the after treatment system.

921G Capacities and specifications

Engine		
Type of oil		CASE AKCELA UNITEK NO. 1™ SBL CJ-4
Technical specifications		SAE 10W-40 API CJ-4
CASE CONSTRUCTION specifications		MAT3521
Type of oil		CASE AKCELA UNITEK NO. 1™ SSL CJ-4 SAE 0W-40 (cold weather)
Technical specifications		SAE 0W-40 API CJ-4
CASE CONSTRUCTION specifications		MAT3521
Capacity (with filter change)		13.25 l (14.0 US qt)
Total capacity in system		15.1 l (16.0 US qt)
Cooling system		
Type of coolant		CASE AKCELA ACTIFULL™ OT EXTENDED LIFE COOLANT
CASE CONSTRUCTION specifications		MAT3624
System capacity		30.0 l (32.0 US qt)
Fuel system		
System capacity		288.0 l (76.0 US gal)
Hydraulic system		
Type of fluid		CASE AKCELA HY-TRAN® ULTRACTION
Technical specifications		ISO VG-46
CASE CONSTRUCTION specifications		MAT 3540
Type of fluid		CASE AKCELA HY-TRAN® ULTRACTION SSL (low temperature)
CASE CONSTRUCTION specifications		MAT 3541
Total system capacity		200.0 l (53.0 US gal)
Reservoir capacity		110.0 l (29.0 US gal)
Transmission		
Type of oil		CASE AKCELA NEXPLORE™ FLUID
Technical specifications		SAE 10W - 30 API GL-4 ISO VG-32/46
CASE CONSTRUCTION specifications		MAT 3525
Service capacity - with filter change		34.1 l (36.0 US qt)
Axles		
Type of oil		CASE AKCELA TRANSAXLE FLUID 80W-140
Technical specifications		SAE 80W-140 API GL-4
CASE CONSTRUCTION specifications		MAT 3510
Front axle		42.0 l (44.4 US qt)
Rear axle		40.0 l (42.3 US qt)
DEF/AdBLUE®		
Technical specifications		ISO 22241-1
CASE CONSTRUCTION specifications		ES-BS001
Total capacity (*)		37.1 L (39.2 US qt)
Grease fittings, as required		
CASE CONSTRUCTION specifications		MAT3550 Grade C

NOTICE: (*) some liters always remains in the **DEF/AdBLUE®** reservoir. This allows for correct functioning of the wheel loader components. **DO NOT** overfill the **DEF/AdBLUE®** tank. The tank is full when the **DEF/AdBLUE®** fluid level in the tank reaches the bottom of the fill neck. Adequate air volume must be present in the top of the tank for proper functionality of the after treatment system.

Consumables - Biodiesel Fuel

Fatty Acid Methyl Ester Biodiesel (Biodiesel Fuel) consists of a family of fuels derived from vegetable oils treated with methyl esters.

NOTICE: Biodiesel fuel blends are approved for your engine only if they comply with Specification Standards EN 14214 or ASTM D6751.

NOTICE: verify with your local dealer which blends are approved for your engine. Use of biodiesel fuel that do not comply with the Standards EN14214 or ASTM D6751 could lead to severe damage to engine and fuel system. Use of non-approved biodiesel fuels may void warranty coverage.

Biodiesel Fuel Usage Conditions

Biodiesel fuels must be purchased from a trusted supplier that understands the product and maintains good fuel quality. Biodiesel fuels must be pre-blended by the supplier. Mixing biodiesel fuels on site can result in an incorrect mixture which can damage engine and fuel system.

Engine performance is effected by the use of biodiesel fuels. There may be up to 12 percent reduction in power or torque depending on the blend used.

NOTICE: DO NOT modify the engine and/or fuel injection pump settings to recover reduced performance.

The reduced power must be accepted if using any biodiesel fuel blends.

NOTICE: the use of high biodiesel fuel blends is not recommended in cold weather conditions.

Using biodiesel fuels may require changing engine oil, engine oil filters, and fuel filter elements more frequently. Biodiesel fuels can remove rust and other particles that adhere to the inside of the fuel tank. These particles are trapped by vehicle filters and may cause shortened filter life or filter blockages. Blockages are more common in cold weather conditions. Consult your dealer for information on cold weather operation and proper maintenance intervals when using any biodiesel fuel blend.

Biodiesel fuel may degrade natural rubber gaskets and hoses, as it is more solvent than petro-diesel. Frequently inspect hoses and other engine components when using biodiesel fuel.

DO NOT allow water to collect in the fuel or storage tanks. Biodiesel fuel attracts moisture from the atmosphere. Keep fuel tanks and storage tanks as full as possible to limit the amount of air and water vapors. It may be necessary to drain machine fuel filter more frequently. Potential oxidation and stability could create a problem with fuel stored in the machine.

Biodiesel Storage

NOTICE: DO NOT store machines for more than six months with biodiesel blends in the fuel system. DO NOT store biodiesel fuel in on-site storage tanks for more than six months.

If long periods of storage are required, run the machine for 20 hours using regular diesel fuel to flush the biodiesel fuel from the engine fuel system.

NOTICE: Biodiesel fuels must not be stored in on-site storage tanks for more than six months. Any spillage of biodiesel fuels must be cleaned up immediately before it can cause damage to the environment or the paint finish of the machine. Before using biodiesel fuel blends, you should consult with your dealer to receive full information about the approved blend for your machine and any detailed conditions of its usage. Failure to follow the requirements and conditions of biodiesel fuel usage will void your machine's warranty.

NOTE: B7 is the highest biodiesel (7% blend) that should be used in this machine.

Hydraulic contamination

Contamination in the hydraulic system is a major cause of the malfunction of hydraulic components. Contamination is any foreign material in the hydraulic oil.

Contamination can enter the hydraulic system in several ways:

- When you drain the oil or disconnect any line
- When you disassemble a component
- From normal wear of the hydraulic components
- From damaged seals or worn seals
- From a damaged component in the hydraulic system

All hydraulic systems operate with some contamination. The design of the components in this hydraulic system permits efficient operation with a small amount of contamination. An increase in this amount of contamination can cause problems in the hydraulic system.

The following list includes some of these problems:

- Cylinder rod seals that leak
- Control valve spools that do not return to neutral
- Movement of control valve spools is difficult
- Hydraulic oil that becomes too hot
- Pump gears, housing, and other parts that wear rapidly
- Relief valves or check valves held open by dirt
- Quick failure of components that have been repaired
- Slow cycle times or a lack of power.

If your machine has any of these problems, check the hydraulic oil for contamination.

There are two types of contamination: microscopic and visible.

Microscopic contamination occurs when very fine particles of foreign material are suspended in the hydraulic oil. These particles are too small to see or feel. Microscopic contamination can be found by identification of the following problems or by testing in a laboratory.

Examples of problems caused by microscopic contamination:

- Cylinder rod seals that leak
- Control valve spools that do not return to neutral
- The hydraulic system has a high operating temperature

Visible contamination is foreign material that can be found by sight, touch, or odor. Visible contamination can cause a sudden failure of components.

Examples of problems caused by visible contamination:

- Particles of metal or dirt in the oil
- Air in the oil
- Dark or thick oil
- Oil with an odor of burned oil
- Water in the oil

If you find contamination, use a portable filter to clean the hydraulic system.

Product identification

The terms right-hand, left-hand, front, and rear are used in this manual to indicate the sides as they are seen from the operator's seat.

1. Front
2. Right-hand
3. Rear
4. Left-hand

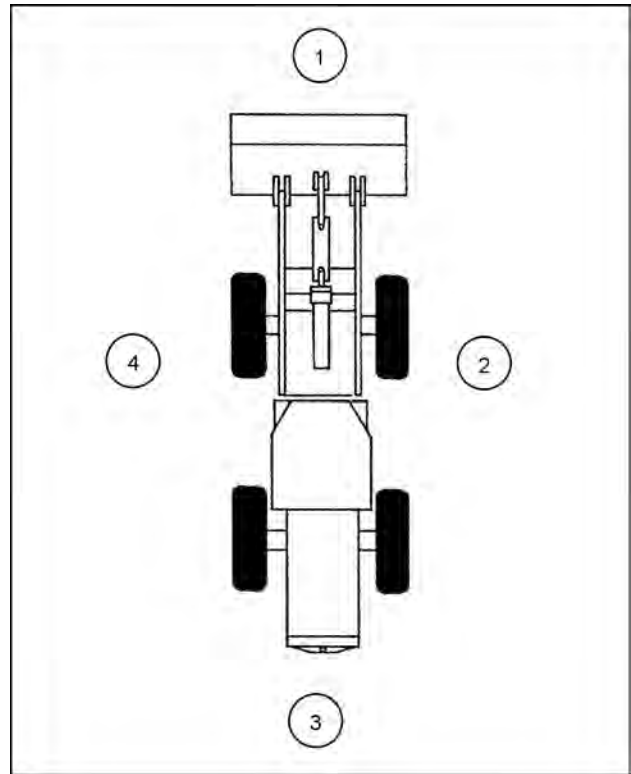

RCPH10WHL003BAH 1

Thanks for your reading.

Please click here to download complete manual instantly.

And can also choose other manuals.

Feel free --->write to me with any questions.

Our service email:

manuals007@hotmail.com